

trotec

Speedy 360

Operating manual



8069

OM 8069_4.2_EN (05/2022)
ENGLISH (Translation)

/ SETTING NEW STANDARDS

(AT)

Trotec Laser GmbH

☎ +43 7242 239-7070
service-at@troteclaser.com

(CA)

Trotec Laser Canada

☎ +1 800 663 1149-902
techsupport@troteclaser.ca

(DE)

Trotec Laser Deutschland GmbH

☎ +49 89 322 99 65-13
service-de@troteclaser.com

(GB)

Trotec Laser UK

☎ +44 0191 4188 110
service-uk@troteclaser.com

(MX)

High Speed Laser Systems S. de R.L. de C.V.

☎ +52 55 5351-7252
mexico@troteclaser.com

(US)

Trotec Laser Inc.

☎ +1 866 226 8505, Option 2
support@troteclaser.com

(AU)

Trotec Laser Pty Ltd

☎ +61 26413-5904
service@troteclaser.com.au

(CH)

Trotec Laser AG

☎ +41 32387-1611
service-ch@troteclaser.com
suisse@troteclaser.com

(ES)

Trotec Laser España

☎ +34 93 102 50 50
soporte@troteclaser.com

(IT)

Trotec Laser Srl

☎ +39 02 9475 5447
supporto.tecnico@troteclaser.com

(NL)

Trotec Laser B.V.

☎ +31 850 70 51 55
support@troteclaser.nl

(ZA)

Rubber Stamp & Engraving

☎ +27 875 509-335
support@trodat.co.za

(BE)

**Trotec Laser België
Trotec Laser Belgique**

☎ +31 850 70 51 55
support@troteclaser.nl

(CN)

Trotec Laser GmbH

☎ +86 189 500 735 62
china@troteclaser.com

(FR)

Trotec Laser France SAS

☎ +33 1 72 62 20 94
techsupport.fr@troteclaser.com

(JA)

Trotec Laser Japan Corporation

☎ Tokyo: +81 42 313 0740
☎ Osaka: +81 6 6180 2200
service-jp@troteclaser.com

(PL)

Trodat Polska Sp. z o.o.

☎ +48 22 339 35 39
serwis_pl@trodat.net

Trotec Laser (XIAMEN) CO., LTD.

#5 GuAn Road South, MaXiang
Town
XiangAn District, XiaMen, China

Trotec Laser GmbH

Freilingerstraße 99
4614 Marchtrenk, Austria

General contact to Technical Support:

Tel.: +43 7242 239-7000

E-mail: techsupport@troteclaser.com

WWW.TROTECLASER.COM

Technical Changes	Technical specifications are subject to change without notice. Trotec Laser GmbH reserves the right to improve or modify any of the products without prior notice.
© Copyright	This documentation with all illustrations is intellectual property of Trotec Laser GmbH. The entire documentation is given to the user for personal use only. Reproduction, translation or any distribution to third parties is not permitted without the prior consent of Trotec Laser GmbH. Any breach of law will be prosecuted.

Content

1	General Information.....	8
1.1	Information about this manual.....	8
1.2	Explanation of symbols.....	8
1.3	Liability and warranty.....	9
1.4	Scope of delivery (standard configuration).....	10
1.4.1	Accessory box.....	10
1.5	Type plate.....	11
2	Safety.....	12
2.1	General safety notes.....	12
2.1.1	Intended use.....	12
2.1.2	Improper use.....	12
2.1.3	Residual risk.....	13
2.1.4	Machine modification.....	13
2.1.5	Operating modes.....	13
2.1.6	Applicable safety regulations.....	13
2.2	Laser safety.....	14
2.2.1	Laser classification.....	14
2.3	Areas of responsibility.....	15
2.3.1	Responsibilities of the operator.....	15
2.3.2	Responsibilities of the operating personnel.....	16
2.4	Requirements for operating an service personnel.....	16
2.5	Warning and information labels.....	18
2.6	Safety devices.....	19
2.7	Technical protective measures.....	19
2.7.1	Main switch.....	19
2.7.2	Key switch.....	19
2.7.3	Interlock safety switches.....	20
2.7.4	Acrylic top lid.....	20
2.7.5	Side cover.....	20
2.7.6	Temperature sensor.....	20
2.8	Secondary (indirect) hazards.....	20
2.8.1	Fire hazard.....	20
2.8.2	Gases, fumes and dust.....	21
2.8.3	Hazards due to damaged optics.....	21
2.8.4	Protective measures for damaged optics.....	22
2.8.5	Reflection through materials.....	23

2.9	In case of emergency.....	24
3	Technical Data.....	25
3.1	Dimensions and weight.....	25
3.2	Network connection.....	26
3.3	Computer connection.....	26
3.4	Electrical requirements of the machine.....	27
3.5	Exhaust system requirements.....	27
3.6	List of materials.....	30
4	Machine overview.....	34
4.1	Anlagenübersicht.....	34
4.2	Ruby server status LED.....	36
4.3	Front door.....	37
4.4	Tables (multifunctional table concept).....	37
4.4.1	Table placement.....	39
4.5	Lens(es).....	41
4.6	Nozzles.....	42
5	Transport.....	43
5.1	Safety notes.....	43
5.2	Delivery state.....	43
5.3	Temperature and humidity.....	44
5.4	Required tools for unloading and transport.....	45
5.5	Place of storage.....	45
5.6	Transport inspection and reporting of defects.....	45
5.7	Unpacking the machine.....	45
5.8	Relocation of the machine.....	46
6	Setup and installation.....	48
6.1	For your safety.....	48
6.2	Temperature and humidity.....	48
6.3	Space requirements.....	49
6.4	Setup.....	49
6.5	Connections.....	50
6.5.1	Mains connection.....	50
7	Connection of additional components.....	51
7.1	Exhaust system.....	51
7.2	Chiller.....	52
8	Operation.....	53
8.1	Before commissioning.....	53
8.2	Power On/Off.....	53
8.3	Control panel.....	55

8.4	Soft buttons on the touch display.....	56
8.5	Keypad.....	57
8.6	USB ports.....	60
8.7	Lense placement.....	60
8.8	Focusing methods.....	61
8.8.1	Focus tool.....	62
8.8.2	Sonar Technologie™.....	63
8.9	Options.....	64
8.9.1	Rotary attachment.....	64
8.9.2	Rotary engraving process.....	64
8.9.3	Installation and commissioning.....	65
8.9.4	Mounting the work piece in the rotary attachment.....	65
8.9.5	Temperature sensor.....	66
8.9.6	Trotec Vision Print&Cut.....	67
8.9.7	Vision Design&Position.....	68
9	Maintenance.....	70
9.1	Safety notes.....	70
9.2	Maintenance plan.....	71
9.3	Daily inspection of the safety circuits.....	71
9.4	Cleaning.....	72
9.4.1	Machine.....	72
9.4.2	Optics in general.....	72
9.4.3	Lens.....	73
9.4.4	Cleaning the mirrors.....	74
9.4.5	Ultrasonic sensor (Sonar Technology™).....	75
10	Troubleshooting.....	76
10.1	Error, cause and remedy.....	76
11	Contact details.....	78
12	Disassembly.....	79
13	Disposal.....	80
14	Appendix.....	81
14.1	Dok III R.....	84
15	Datasheet 8069 Speedy 360 C.....	85
16	CE_8069_Speedy360_Konformitätserklärung_D.....	88

1 General Information

For the sake of readability, gender-neutral endings are not used in this operation manual. It is hereby expressly stated that all parts of the text where natural persons or groups of persons are mentioned refer to people of all genders.

1.1 Information about this manual

**Before beginning any work on the machine, read this manual completely and carefully.
Keep the manual for further consultation close to the machine.**

This manual describes how to operate the machine properly and safely. Be sure to follow the safety instructions given here, as well as any local accident prevention regulations and general safety regulations applicable to the field of usage. Before beginning any work on the machine, ensure that the manual, in particular the chapter entitled "Safety Information" and the respective safety guidelines, has been read in its entirety and fully understood.



Information

Supplementary documentation can be found on the supplied storage medium. You can also request this from the manufacturer.

1.2 Explanation of symbols

Important technical safety notes and instructions in this manual are indicated by symbols. It is important to observe and follow these notes and instructions on workplace safety. Avoid accidents, personal injury and material damage to property by acting with extreme caution.



Danger

This symbol indicates an imminently hazardous situation which, if not avoided, will result in death or serious injury.



Warning

This symbol indicates a potentially hazardous situation which, if not avoided, could result in death or serious injury.



Warning Dangerous electrical voltage

This symbol warns of potentially dangerous situations related to the electric voltage. Failure to observe the safety instructions leads to risk of serious injury or death. Particular care should be taken during maintenance and repair work.



Warning Laser

This symbol warns of potentially dangerous situations related to the laser beam. Failure to observe the safety instructions leads to risk of serious injury.



Caution

This symbol indicates a potentially hazardous situation which, if not avoided, could result in minor or moderate injury.



Notice

This symbol indicates potential risks of damage to the supported product (or to property).
In addition, non-observance may result in damage, malfunction or failure of the machine.



Information

This symbol indicates tips and information which must be observed for efficient and trouble-free handling of the product.



Disposal

This symbol indicates notes regarding the professional disposal of the product or accessories.

1.3 Liability and warranty

Warranty periods specified in the manufacturers "warranty terms and conditions" shall be binding for the buyer. If no warranty periods are specified, the general terms and conditions of sale, delivery and payment apply.

All information, illustrations, tables, specifications and diagrams contained in this operating manual have been carefully compiled according to the current state of technology. No liability is accepted with regard to errors, missing information and any resulting damage or consequential loss.

Strict compliance with the safety procedures described in this operating manual and extreme caution when using the equipment are essential for avoiding and reducing the possibility of personal injury or damage to the equipment. The manufacturer shall not be liable for any damage and or faults resulting from nonobservance of instructions in this manual.

Nonobservance of the operation, maintenance and service instructions described within this manual absolves Trotec Laser GmbH from any liability in case of a defect.

Furthermore, Trotec Laser GmbH shall accept no liability whatsoever for damage caused by the use of non-original parts and accessories.

Additionally, Trotec Laser GmbH shall not be held responsible for any personal injury or property damage, of an indirect or specific nature, consequential loss, loss of commercial profits, interruption to business, or loss of commercial information resulting from use of the equipment described in this manual.

It is strictly prohibited to make any alterations, to prepare translations, decompile, disassemble, reverse engineer or copy the software.

Trotec Laser GmbH reserves the right to update any of the information, illustrations, tables, specifications and diagrams contained in this operating manual with regard to technical developments at any time without notice.

General Information

1.4 Scope of delivery (standard configuration)

- Laser machine
- Storage medium (includes manuals)
- Focusing tool(s) (according to lens order)
- Cleaning kit for optics
- Nozzles (ø3 and ø7)
- Lenses according to order
- Working tabel according to order
- Allen key kit (8-part)
- Exhaust connection cable (according to order)
- I/O-Plug
- Network cable

The actual scope of delivery may be different, depending on the special model, additional order options or newest technical changes.

1.4.1 Accessory box



- Lens Tissue (100pcs)
- Nozzles (ø3 und ø7 mm)
- Standard lens CO2 2.0" / flexx 2.85" additionally
- CAT 5e LAN cable 5,0m
- Storage medium
- Allen key kit
- Speedy Series Quick reference guide
- Safety- and Maintenance guide

1.5 Type plate

The type plate with the CE mark is located on the rear of the machine.

Enter the serial number, model and year of manufacture into your manual and always refer to them when contacting us for enquiries, troubleshooting or ordering of replacement parts.

Serial number:	
Model:	
Year of manufacture:	

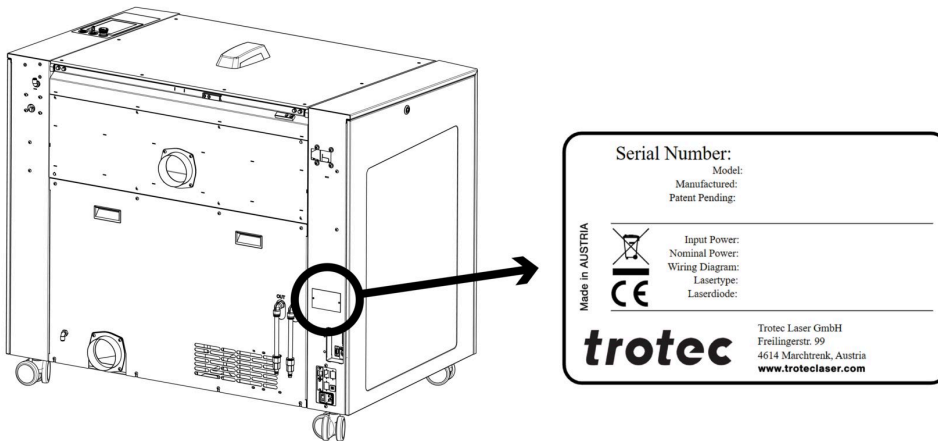

2 Safety

TO AVOID POSSIBLE HARM READ AND FOLLOW THESE INSTRUCTIONS.

The machine is built at the time of its development and production according to applicable, established technical rules and is considered to be safe to operate.

Dangers can be caused by the machine if the machine:

- is operated by unqualified personnel,
- the personnel have not been trained,
- the machine is used improperly or not as intended,
- or if the machine is used for other intended purposes.

This chapter provides an overview of all important safety aspects that are necessary for optimum protection of persons and safe and trouble-free operation of the machine. Other chapters of this manual contain specific safety notes for the avoidance and prevention of hazards.

2.1 General safety notes

2.1.1 Intended use

The machine described in this manual is intended for cutting, engraving and marking of materials according to the intended use of the machine, using the supplied software.

The system must be operated, maintained and repaired only by trained personnel familiar with the designated field of use and the dangers of the machine!

Operate the machine only in technically flawless condition and when it fully complies with the EC Machinery Directive.

For material details see chapter "List of materials" or contact your local Trotec representative, or our Technical Support.

The machine may only be operated with a suitable and effective exhaust system.

The intended use of this machine also includes that all personnel involved in installation, set-up, operation maintenance and repair of the machine must have read and understood the operating manual and in particular the "Safety" section, and comply with the instructions.

2.1.2 Improper use

Use of the machine for any purposes other than those intended or described in the present manual is regarded as improper and therefore prohibited. Trotec Laser GmbH will not accept any liability for damage caused by improper use. The operator is solely liable for all damages caused by improper use.

Non-observance of the operation, maintenance and service instructions described within this manual absolves Trotec from any liability in case of a defect.

2.1.3 Residual risk

Even if all safety regulations are observed, a residual risk remains when operating the machine.

2.1.4 Machine modification

It is strictly prohibited to alter, refit or modify the machine in any way without the express consent of the manufacturer.

Likewise, it is strictly prohibited to remove, bridge or bypass any safety devices. Operating conditions and connection and setup values stated in the data sheet must be complied with at all times.

Operation of the system is permitted only with original parts and accessories by the manufacturer. Use of third-party parts affects machine safety.

2.1.5 Operating modes

NORMAL OPERATION

For normal operation the following conditions must be met:

- Intended use of the machine (see chapter "Intended use").
- Operation of the machine only by trained personnel.
- Full functional and mounted safety devices.
- Machine must be in technically flawless condition.
- Processing of permissible materials according to the material list.
- Maintenance and service are not included.



Notice

During normal operation it is not necessary to wear safety glasses.

SERVICE OPERATION

Service activities may be carried out only by authorized, trained service technicians. If side panels as well as covers get removed and safety devices get bypassed, it can lead to direct and indirect scattered radiation. The service operation is therefore declared as laser class 4 (US: class IV) and proper precautions need to be taken (see "Laser classification").

2.1.6 Applicable safety regulations

The following directives and guidelines must be observed to avoid hazards when operating Trotec laser systems:

GUIDELINES/REGULATIONS

2006/42/EC

EC Machinery Directive

2014/30/EU

EMC Guideline

APPLIED HARMONIZED STANDARDS

EN ISO 12100:2011-03	Safety of machinery - General principles for design - Risk assessment and risk reduction.
IEC 60825-1:2014, EN 60825-4:2011	Safety of laser products - Part 1: Equipment classification and requirements.
IEC 60204-1:2005	Safety of machinery - Electrical equipment of machines - Part 1: General requirements.
ISO/DIS 11553-1:2009-03	Safety of machinery - Laser processing machines - Part 1: General safety requirements.
IEC 61000-6-4:2007-02	Electromagnetic compatibility (EMC) - Part 6-4: Generic standards - Emission standard for industrial environments.
ISO 13857:2008	Safety of machinery - Safety distances to prevent hazard zones being reached by upper and lower limbs.
EN 55011+A1:2016-05	Industrial, scientific and medical equipment - Radio-frequency disturbance characteristics - Limits and methods of measurement.
IEC 60825-4:2012-01-01	Safety of laser products - Part 4: Laser guards



Notice

Safety norms and regulations.

The general guidelines and directives listed within this manual may differ according to locality, region or country.

Therefore, always observe the directives as well as the regulations of the institutions for statutory accident insurance association applicable to you. The operator is responsible for fulfilling all safety requirements, as Trotec Laser GmbH has no influence on the proper use of the machine.

Observe the official regulations for your business location in accordance with the applicable local legal regulations (on accident prevention regulations or employee protection), e.g. DGUV regulation 11 for Germany.

2.2 Laser safety

2.2.1 Laser classification

The laser safety class indicates the risk potential from accessible laser radiation.

The laser system is a Class 2 (US: Class II) laser marking system as per IEC 60825-1 "Safety of Laser Product".

The integrated laser source is a Class 4 (US: Class IV) laser marking system according to IEC 60825-1 and identified as such.

Class 2 (US: class II)

The accessible laser radiation of Class 2 (US: Class II) laser systems does not pose any hazard for the skin. Diffuse reflections as well as any short-term irradiation of the eyes (exposure time max. 0.25 seconds) also pose no risk due to the low output power. However, it is possible to suppress the natural eyelid closure reflex and stare into the class-2 laser beam for a time long enough for the eyes to get injured.



Warning Laser

Laser radiation of Class 2 (US: class II)

For Class 2 (US: class II) laser is short term exposure (up to 0.25 seconds) harmless to the eyes and can therefore be operated without additional protective measures. However it can cause irritation of the eyes if the natural avoidance reaction (staring into the laser beam deliberately) or eyelid closure reflex is suppressed.

- Do not suppress the eyelid closure reflex.
- Do not stare directly into the laser beam.
- Close eyes, turn away.
- Never look at the laser beam directly with an optical instrument, e.g. a lens.



Notice

It is the responsibility of the operator to comply with the national official and statutory regulations for the operation of a laser system with a build in laser source of class 4 (US: class IV).

2.3 Areas of responsibility

2.3.1 Responsibilities of the operator

The operator has the following responsibilities:

- It is the responsibility of the operator to comply with the national official and statutory regulations for the operation of a class 4 (US: class IV) laser system or laser system with a build in laser source of class 4 (US: class IV).
- In addition to the safety notes and instructions stated in this manual, consider and observe the local accident prevention regulations and general safety regulations that apply at the operation site of the machine.
- A CO₂ fire extinguisher must always be at hand, as the laser beam can ignite flammable materials.
- If the machine is used industrially, the operator is subject to the legal obligations concerning industrial safety.
- All personnel involved in installation, set-up, operation, maintenance and repair of the machine must have read and understood this manual and in particular the "Safety" section. The personnel must be trained and informed about all the functions, potential dangers and safety issues of the machine on a yearly basis.
- The user is recommended to prepare company internal instructions considering the occupational qualifications of the personnel employed in each case, and the receipt of the instruction/this manual or the participation in the introduction/training should in each case be acknowledged in writing.
- Keep the manual in the immediate vicinity of the machine so that it is accessible at all times to all persons working on or with the machine.

- Authority for the individual activities relating to the application of the machine (e.g. installation, operation, maintenance and cleaning) must be clearly defined and observed, so that no unclear competencies result under the aspect of safety. This applies in particular to work to be performed on the electrical equipment that may only be performed by qualified specialists.
- Maintenance and repair work as specified in the manual must be carried out regularly.
- For all activities concerning installation, set-up, start-up, operation, modifications of conditions and methods of operation, maintenance, inspection and repair, the switch-off procedures that may be provided in the manual must be observed.
- Provide appropriate personal protection equipment (e.g. protective goggles according to wavelength and laser power).
- The operator is responsible for the safety-related state of the machine.
- Do not store any flammable materials in the working area or in the immediate vicinity of the device. Particularly, residues of processed materials have to be removed to prevent any fire hazard.
- The operator must ensure cleanliness and accessibility at and around the machine by corresponding instructions and controls.

2.3.2 Responsibilities of the operating personnel

The operating personnel has the following responsibilities:

- Always wear personal protective equipment.
- It is the duty of the operating personnel to check the machine before start of work for externally visible damage and defects, and to immediately report any changes that appear (including behavior during operation) that may affect the safety of the machine. It must be made sure that the machine is operated only in perfect condition.
- The machine must not be left unattended while it is operating (supervised operation).
- Switch off the machine described herein at the main switch for periods of non-use.
- Operate the machine described here only with a lens in place. A missing lens may cause the unfocused laser beam to be reflected out of the housing.
- Stop this machine immediately in case of failure.
- No working methods are permitted that affect the safety of persons or of the machine.
- The machine and its components, such as the lens and mirrors, are to be kept clean at all times.



Caution

The adjustment of the beam path may only be carried out by service personnel of Trotec Laser GmbH.

2.4 Requirements for operating an service personnel

The requirements for the operating and service personnel are:

- The personnel must have read and understood this manual and in particular the "Safety" section.
- The personnel must not be under the influence of drugs, alcohol or reactivity affecting medication when working on or with the machine.

- The personnel must be familiar with using the CO₂ fire extinguisher.
- The personnel must be trained in order to be qualified to operate the machine. If the personnel lack the necessary knowledge for working on or with the machine, they must first be trained and note down the training in the training verification form.

Activity	Intended user group	Definition
Control/operation/other activities (e.g. troubleshooting, maintenance)	Qualified personnel or Trotec service technicians	Qualified personnel are those who can judge the work entrusted to them and detect potential risks based on their occupational training, knowledge and experience as well as their understanding of the relevant regulations.

2.5 Warning and information labels

The warning and information labels are attached to the device at those points which could represent a source of danger before commissioning or during operation. Therefore, pay special attention to the information on the labels.

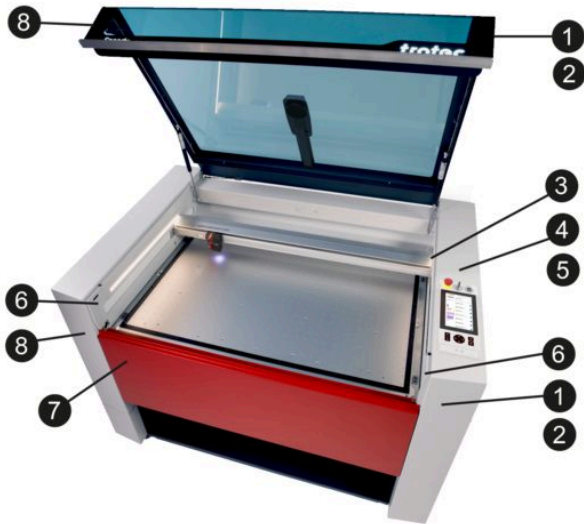

Caution

Lost or damaged warning and safety stickers.

If any warning and safety stickers are lost or damaged, the user is not able identify risks anymore, and there is danger of injury.

- Replace lost or damaged labels immediately.
- Contact your Trotec Laser GmbH dealer for details.

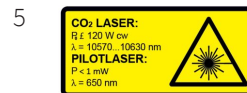
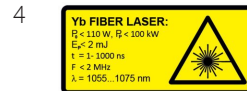

2.6 Safety devices



Warning

Danger from laser beam.

Safety and protection devices that are not installed or are not fully functional can lead to bodily injury and material damage.

- Do not remove, modify or deactivate the interlock safety switches or protective covers on the machine. Safety and protection devices must be fully functional at all times.
- In case of assumed or presumed damage of safety devices, disconnect the machine from the mains.
- Damaged safety and protection devices need to be replaced by a Trotec technician immediately.

2.7 Technical protective measures

2.7.1 Main switch

Pressing the main switch on the backside of the machine to disconnect the machine from the mains power supply.

2.7.2 Key switch

Turning the key switch counterclockwise powers off the motor, laser source and electric system. The operation of the machine by unauthorized persons can be prevented by securing the key switch.

Pressing the emergency stop button causes the machine to stop immediately and the laser source to be switched off. The laser beam is interrupted and all movements are stopped.

ACKNOWLEDGE THE EMERGENCY STOP SWITCH

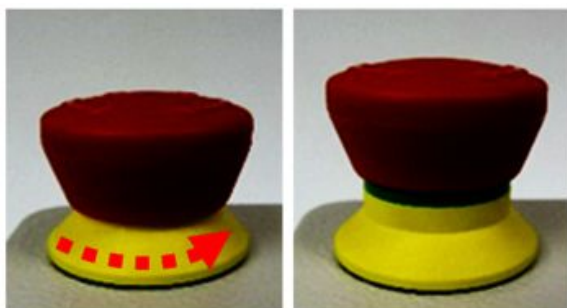

1. Turn the emergency stop switch counterclockwise to unlock it so that the green marking is visible.
2. Restart the laser system using the key switch.

2.7.3 Interlock safety switches

Interlock safety switch query the closed status of the acrylic top lid, side panels and front door. If the safety devices are open or not present, the laser cannot be operated. However, the pilot laser stays active.

2.7.4 Acrylic top lid

The type of acrylic top lid depends on the laser type. It protects the operator from uncontrolled emission of dangerous laser radiation.

2.7.5 Side cover

The side panels protect from laser light and must always be closed and properly attached.

2.7.6 Temperature sensor

The temperature sensors ensure reliable temperature monitoring of the interior of the machine and are available as additional option.

Actual or presumed damage to the safety devices can cause injury or damage. Following measures must be carried out.

1. Press the emergency stop button.
2. Disconnect the machine from the mains (main switch, power supply).
3. Contact our Technical Support in your local area.

2.8 Secondary (indirect) hazards

2.8.1 Fire hazard



Warning **Fire hazard**

Fire hazard from gas and processing of inflammable materials.

- Do not operate the device without supervision.
- Keep CO₂ fire extinguisher ready at hand in the immediate vicinity of the device.

If a main laser beam hits easily flammable material, e.g. paper, this may ignite and a fire can quickly occur. Therefore, before switching on the laser, you should make absolutely sure that there is no easily flammable material in the beam path.

Furthermore, gases that can form below the material to be processed may ignite. Especially if the extraction requirements are not met.

Inadequate care and cleaning of the system increases the risk of flame formation.

Regularly check the cooling slots of the cooling system.

2.8.2 Gases, fumes and dust

Depending on the materials being processed and the parameters selected, laser processing may generate gases, fumes, aerosols or dust. Depending on the material, such by-products may be toxic. In individual cases, the reaction products may be electrically conductive dusts. If these enter electric systems, short-circuiting with personal injury and property damage may occur.

The operator is responsible for ensuring presence of a suitable extraction system and compliance with the relevant guidelines in order to protect persons and the environment. The guideline VDI 2262 1-3 "Workplace air" provides, among other things, additional remarks.

The operator must also ensure that gases, fumes or dust do not settle on the processing lens. Any dirt accumulating on the processing lens can lead to loss of performance, poor processing results and damage to the device.

2.8.3 Hazards due to damaged optics



Warning

Damage to optics.

Soiled optics absorb laser radiation and can thus be destroyed. Broken or damaged lenses as well as thermal decomposition of lenses release particles which cause serious damage to the health.

- The passive reflectors and optics in the area of the laser beam guidance should be cleaned regularly.
- Special care is required when handling, attaching and cleaning these elements.
- Do not exert non-uniform pressure.
- Do not use tools or hard objects to clean the surface.
- Never touch the optics with your bare fingers.
- Never use cleaning tissues twice.
- When lenses get broken, damaged or thermal decomposed follow the protective measures.
- Disposal according to regulations and laws valid in the user's country.
- **Lenses with scratches or lenses with penetrations must not be used anymore!**

SCRATCHED OR DESTROYED LENS SURFACE

Be aware that scratches in the coating may release small quantities of thorium, which may be harmful upon inhalation or swallowing.

THERMAL DECOMPOSITION

Upon thermal decompositions, vapors of selenium oxide and zinc oxide are formed. Upon inhalation or swallowing there is danger of poisoning. Indicators for thermal decomposition of ZnSe include deposits in the form of red or white powder and an unpleasant odor.

BROKEN LENSES

When optical components of zinc selenide (ZnSe) are destroyed, toxic dusts and vapors are formed which must not be inhaled. The dust can additionally cause irritations of the eyes, skin and respiratory tract. If a lens has been destroyed during operations, care is to be taken during removal and cleaning.

2.8.4 Protective measures for damaged optics

Protective measures in case of thermal decomposition and scratched or broken lenses

- For disposal use a protective mask or respiratory filter to prevent inhalation or ingestion of thorium.
- Wash hands thoroughly after contact with a scratched coating.

Protective measures in case of a broken lens

- Upon perception of an unpleasant odor, switch off the machine.
- Hold your breath.
- Leave the area of the machine.
- Before approaching the system again, wait for at least 30 min until the reaction has abated.
- Wear proper protective clothing (respiratory protection, protective goggles, protective suit, rubber or plastic gloves).
- Provide ventilation.
- When approaching the system again, pay attention to odors.
- Remove all lens fragments.
- Avoid raising or dispersing dust.



Disposal

The ZnSe dust and the lens are to be collected drily and disposed of with fragments, broom, shovel and protective clothing into hermetically sealable containers or plastics bags as hazardous waste.

Do not dispose of optical components as domestic waste, and do not let them enter the sewer or water bodies.

Dispose of according to regulations and laws valid in the users' country.

2.8.5 Reflection through materials



Warning

Danger from laser beam.

Invisible laser radiation of reflecting materials can cause serious injury or material damage.

- Only material according to the intended use of the machine may be used.
- Do not use material with high reflecting surfaces such as aluminum, chromium, precious metals, metal foils, stainless steel, brass, copper and titanium.
- Take special care with surfaces formed convex and concave.
- Do not leave or put objects on the work surface/working area.

LASER BEAM REFLECTION

The reflecting law is valid for the reflection of the laser radiation: **Angle of incidence = failure corner**

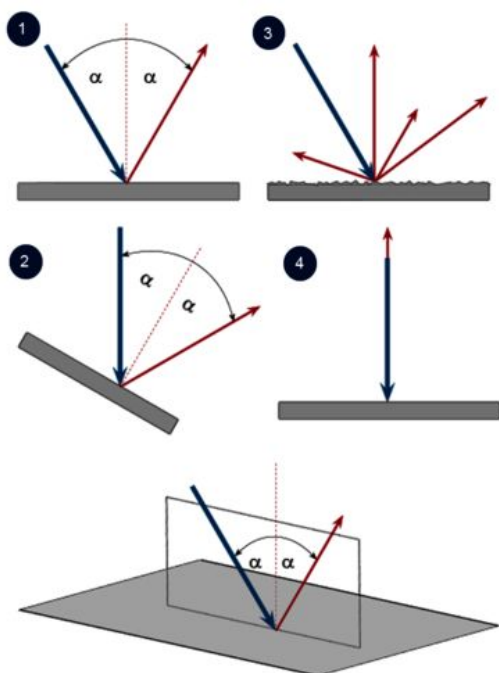

No.	Description
1	Directed reflection: Reflected ray on smooth surface.
2	Directed reflection: Reflected ray on sloping surface.
3	Diffuse reflection: Reflected ray on rough surface.
4	Directed reflection: Horizontally reflected ray on smooth surface.

2.9 In case of emergency

WHAT TO DO IN THE EVENT OF MALFUNCTIONS

- In unusual operating conditions, open the lid to stop the machining process press the emergency stop button and switch off the machine.
- If necessary, disconnect the machine from the main power supply.
- Inform the laser protection officer and your supervisor.
- Repair work must only be carried out by Trotec Laser GmbH service technicians.
- In the event of a fire: Fight the fire with a CO₂ fire extinguisher as far as is possible without risk.



Notice

After a deletion, Trotec Technical Support must be involved before the system is put back into operation.

WHAT TO DO IN THE EVENT OF AN ACCIDENT, FIRST AID

- If eye damage occurs due to laser radiation, the casualty must present to an ophthalmologist immediately.
- First aiders must protect themselves.
- Disconnect the device from the power supply and secure it against restarting
 - Remove the key switch.
 - Unplug the power cable.
- Rescue the injured person from the danger area and provide first aid.
- Call an emergency doctor!

3 Technical Data

→ The technical data sheet can be found in the appendix of this manual.

3.1 Dimensions and weight

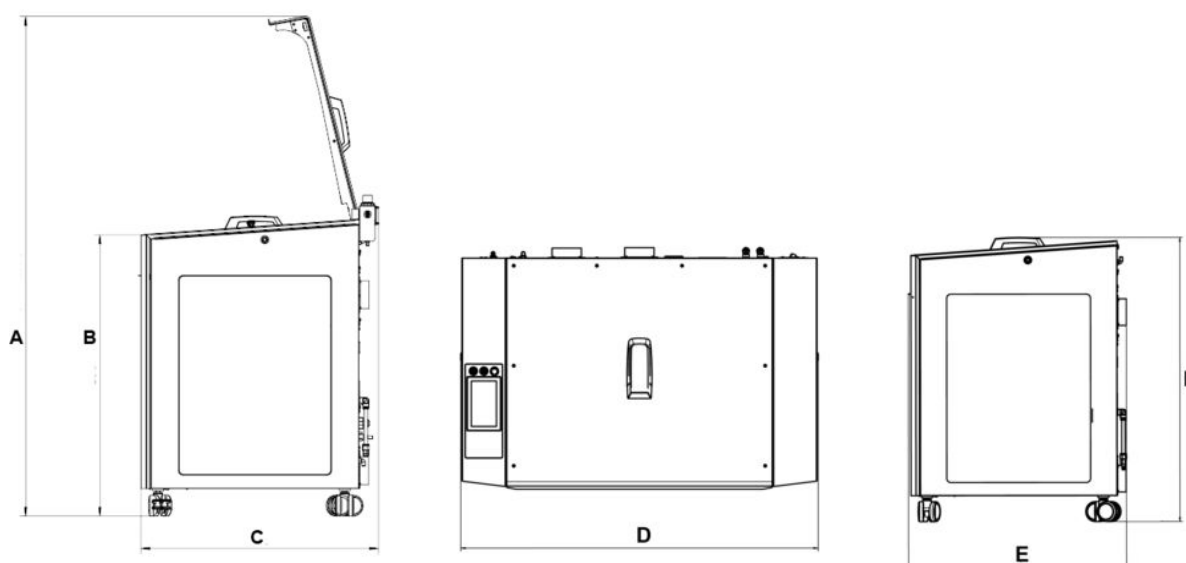

	Description	Dimension
A	Height front side with open lid	1774 mm (69.8 inch)
B	Height front side	998 mm (39.3 inch)
C	Depth with exhaust hose connection and gas kit light	843 mm (33.2 inch)
	Depth without exhaust hose connection and gas kit light	790 mm (30.7 inch)
D	Length	1221 mm (48 inch)
E	Depth with exhaust hose connection but without gas kit light	819 mm (32.2 inch)
F	Height back side with Vision Design&Position	1066 mm (42 inch)
	Weigh (depending on the laser power)	235 bis 250 kg (518 to 551 lbs)

3.2 Network connection

RECOMMENDATIONS PC

Client

- Operation System: 64 bit
- Screen Resolution: min. 1920x1080 (FullHD)
- Browser: latest Google Chrome
- RAM: min. 4GB
- Processor: min. i5

Network

- DHCP Active
- 100Mbit Speed
- CAT5e or higher
- Wifi: 2,4GHz or 5GHz

3.3 Computer connection

Connect the machine to the local network port using a LAN cable or plug in the optional Wifi dongle on the back of the machine.

The network settings must be set up when the machine is first started.

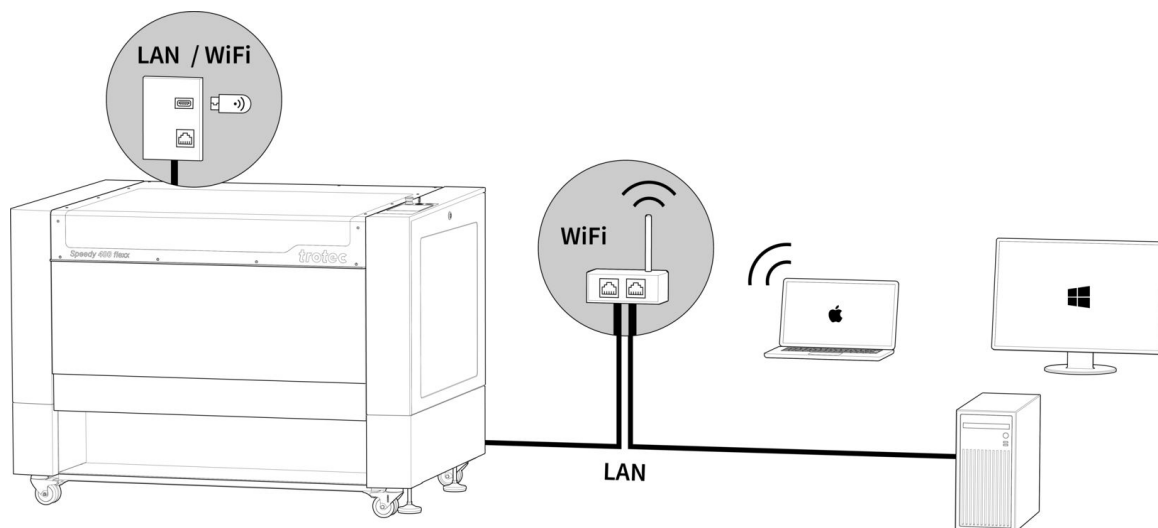

Information

Information on the connections can be found in the chapter "[General overview](#)".

3.4 Electrical requirements of the machine

Laser power	55–80 W (TL4 CO ₂) 20-50 W (fiber)		85–100 W (TL6 CO ₂) 20-50 W (fiber)	105–120 W (TL8 CO ₂) 20-50 W (fiber)
Voltage	230 V~	115 V~	230 V~	230 V~
Fuse	8A (T)*	16A (T)*	12A (T)*	12A (T)*
Power consumption AC and WC	1590 W	1590 W	2100 W	2100 W

* T = time lag (slow triggering)



Caution

Inadequate or inappropriate power sources can lead to machine damage and are not covered by any liability.

Verify that the electrical outlet is capable of providing the proper voltage, frequency and amperage required by the laser machine described in this manual.



Caution

Electrical noise, unstable power supply as well as voltage spikes in power supply can cause interference and possible damage to the electronics of the laser machine.



Notice

Use an individual circuit for the laser machine and the PC and an individual circuit for the exhaust system. Install your computer to the same circuit as the laser machine to prevent electromagnetic interactions.

Furthermore it is highly recommended that you use a overvoltage protection switch to protect your computer equipment.

If electrical power fluctuations, brownouts or power outages are a problem in your area, an electrical line stabilizer, UPS (Uninterruptible Power Supply) or backup generator are required. When installing any of these devices, ensure that they meet the electrical requirements of the laser machine.

3.5 Exhaust system requirements



Danger

Danger of emission of toxic gases, vapors or dust.

During laser operation, toxic aerosols may be produced.

- The laser system may be operated only with properly installed and operating exhaust system.
- Check with the material manufacturer for its toxic effect.



Caution

The laser may only be operated with properly installed and operating exhaust system. Damage to the system, caused by the use of not any exhaust system or improper extraction equipment, will not be covered by any liability.

The requirements for the exhaust system and recommended Trotec exhaust systems for standard applications depend on the working table installed in the machine.

RECOMMENDED EXHAUST SYSTEMS FOR SPEEDY SERIE:

Exhaust system	Speedy 360
Atmos Mono	✓ (without table exhaust)
Atmos Mono Plus	✓ (without table exhaust)
Atmos Duo Plus	✓
Vent Set 400	✓ (without vacuum table)
Vent Set 500	✓



Notice

Connection has to be carried out by our Technical Support.

Observe instructions for operation and maintenance according to the operating manual of the exhaust system.

TECHNICAL DATA OF THE CORRESPONDING EXHAUST SYSTEMS:

Exhaust system	Hose connection \varnothing [mm] (inside diameter)	Volume flow [m ³ /h]	Pressure [Pa]
Atmos Mono	70 / 70 / 45	320	8500 (230V) 5800 (115V)
Atmos Mono Plus	70 / 70 / 45	320	8500 (230V) 5800 (115V)
Atmos Duo Plus	70 / 70 / 45	(2x) 320	8500 (230V)
Vent Set 400	100	max. 1000	max. 3800
Vent Set 500	100	max. 1200	max. 7000

REQUIREMENTS FOR THE EXHAUST SYSTEM:

Machine	Volume flow [m ³ /h]	Pressure [Pa]
Speedy 360	300 (without table exhaust)	2500 (without table exhaust)
	400 (with table exhaust)	4200 (with table exhaust)

The monitoring point for flow rate and pressure is at the exhaust port at the laser machine. Pressure loss by hoses / pipes or filter parts of the exhaust system has to be determined and additionally calculated when selecting a proper exhaust system.

A powerful exhaust system keeps the lifetime of optics and mechanical components, the cutting quality and the laser power interacting with the workpiece from being impaired by fumes and dust accumulating in the machine.



Notice

The exhaust power available for the application will be reduced by e. g. bends, small hose diameters and long hoses.

You should therefore note the following:

- Avoid bends.
- Keep hose as short as possible.
- Use hose diameters as large as possible.

Applications generating large amounts of dust or fumes may require a stronger exhaust system. Use of separate exhaust systems for head and table exhaust may also be necessary.

In this case it is absolute necessary to consult your distributor.

3.6 List of materials

Material EN	Material DE	Cutting			Engraving			Marking		
		CO ₂	Fiber	Flexx	CO ₂	Fiber	Flexx	CO ₂	Fiber	Flexx
Metal										
Aluminum	Aluminium					✓	✓		✓	✓
Aluminum, anodized	Aluminium, eloxiert					✓	✓	✓	✓	✓
Chromium	Chromium Verchromte Oberflächen					✓	✓		✓	✓
Precious metal	Edelmetalle					✓	✓		✓	✓
Metal foils up to 0.5mm (Aluminum, Brass, Copper, precious metal)	Metallfolien bis zu 0,5mm (Aluminium, Messing, Kupfer, Edelmetall)		✓	✓		✓	✓		✓	✓
Stainless steel	Edelstahl					✓	✓		✓	✓
Metal, painted	beschichtetes Metall (lackiert)				✓		✓			
Brass	Messing					✓	✓		✓	✓
Copper	Kupfer					✓	✓		✓	✓
Titanium	Titan					✓	✓		✓	✓

Plastic										
Acrylonitrile butadiene styrene (ABS)	Acrylnitril-ButadienStyrol-Copolymer (ABS)	✓		✓	✓		✓		✓	✓
Acrylic/PMMA, i.e. Plexiglas®	Acryl(PMMA), z.B. Plexiglas®	✓		✓	✓		✓		✓	✓
Rubber	Gummi (Stempelgummi)	✓		✓	✓		✓		✓	✓
Polyamide (PA)	Polyamid (PA)	✓		✓	✓		✓		✓	✓
Polybutylene terephthalate (PBT)	Polybutylenterephth (PBT)	✓		✓	✓		✓		✓	✓
Polycarbonate (PC)	Polycarbonat (PC)	✓		✓	✓		✓		✓	✓
Polyethylene (PE)	Polyethylen (PE)	✓		✓	✓		✓		✓	✓
Polyester (PES)	Polyester (PES)	✓		✓	✓		✓		✓	✓
Polyethylene terephthalate (PET)	Polyethylenterephth (PET)	✓		✓	✓		✓		✓	✓
Polyimide (PI)	Polyimid (PI)	✓		✓	✓		✓		✓	✓
Polyoxymethylene (POM) -i.e. Delrin®	Polyoxymethylen (POM) z.B Delrin®	✓		✓	✓		✓		✓	✓
Polypropylene (PP)	Polypropylen (PP)	✓		✓	✓		✓		✓	✓
Polyphenylene sulfide (PPS)	Polyphenylensulfid (PPS)	✓		✓	✓		✓		✓	✓
Polystyrene (PS)	Polystyrol (PS)	✓		✓	✓		✓		✓	✓
Polyurethane (PUR)	Polyurethan (PUR)	✓		✓	✓		✓		✓	✓
Foam (PVC free)	Schaumstoff (PVC frei)	✓		✓	✓		✓		✓	✓

Miscellaneous										
Wood	Holz	✓		✓	✓		✓			
Mirror	Spiegel					✓	✓		✓	✓
Stone	Stein				✓		✓			
Paper (white)	Papier (weiß)	✓		✓	✓		✓	✓		✓
Paper (colored)	Papier (farbig)	✓		✓	✓		✓	✓	✓	✓
Food	Lebensmittel	✓	✓	✓	✓		✓	✓		✓
Leather	Leder	✓		✓	✓		✓	✓		✓
Fabric	Textilien	✓		✓	✓		✓			
Glass	Glas				✓		✓			
Ceramics	Keramik					✓	✓	✓	✓	✓
Cardboard	Karton	✓		✓	✓		✓	✓		✓
Cork	Kork	✓		✓	✓		✓	✓		✓
	Markierungsmittel (auf Metall oder Keramik/Glas) z.B. markSolid				✓		✓	✓		✓



Warning

Prohibited materials:

- Leather and artificial leather that contains chromium (VI)
- Carbon fibers (Carbon)
- Polyvinyl chloride (PVC)
- Polyvinyl butyral (PVB)
- Polytetrafluorethylene (PTFE, Teflon)
- Beryllium oxide
- Materials containing halogens (fluorine, chlorine, bromine, iodine and astatine), epoxy or phenolic resins.

Take care when processing the following materials:

- Manganese
- Chromium
- Nickel
- Cobalt
- Copper
- Lead
- any material with the naming addition “flame-retarding” since it might contain bromine.



Warning

Serious injury or material damage.

The use of prohibited or unreleased materials can cause serious injury or material damage and will not be covered under warranty.

Only use approved and released materials.



Notice

Please contact our experienced application specialists or a sales partner near you, if:

- You are unsure about the processing of a material.
- You have additions for further materials for us or in your opinion a material was not listed.

We recommend performing a material processing test with the above mentioned material, using the appropriate configuration.

Trotec Laser GmbH assumes no responsibility for any consequences of laser processing in any application, especially with medical or pharmaceutical applications.

4 Machine overview

4.1 Anlagenübersicht

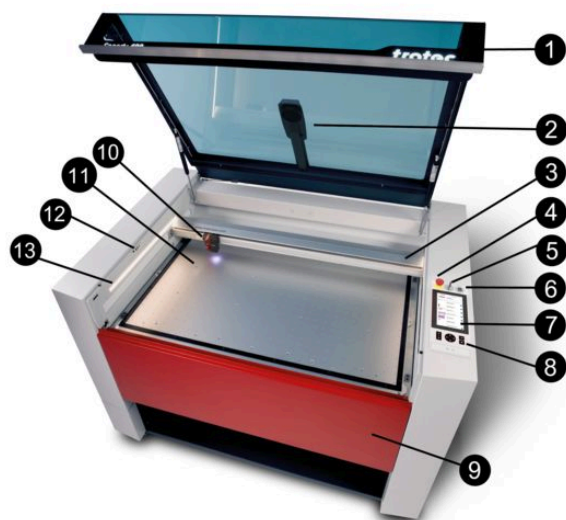

No	Description	No	Description
1	Top lid	8	Keypad
2	Vision Design&Position	9	Front door
3	X-axis	10	Laser head
4	Emergency stop button	11	Working table
5	Key switch	12	Ruby server status LED
6	USB ports	13	LED Interior lighting
7	Touch display		



No	Description	No	Description
14	Connector for exhaust tube (working area)	16	Type plate
15	Cover for laser source	17	Connector for exhaust tube (working table)

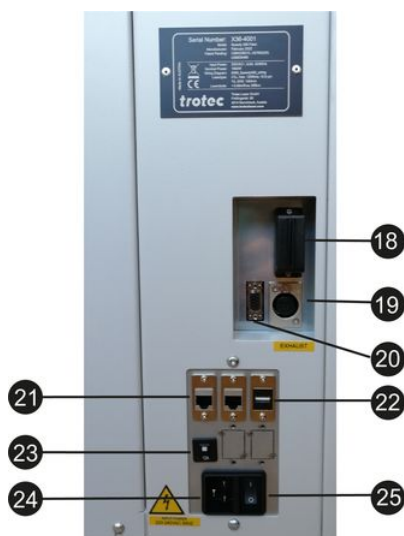

No	Description	No	Description
18	I/O interface	22	WLAN Dongle
19	Service plug connector	23	Fuse
20	Connector for exhaust tube	24	Mains connection
21	LAN	25	Main switch

4.2 Ruby server status LED

The Ruby server status LEDs are located on the left side above the LED interior lighting inside the laser machine.

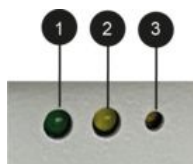

Description

- 1** Green: power
- 2** Yellow: activ
- 3** Reset button

4.3 Front door

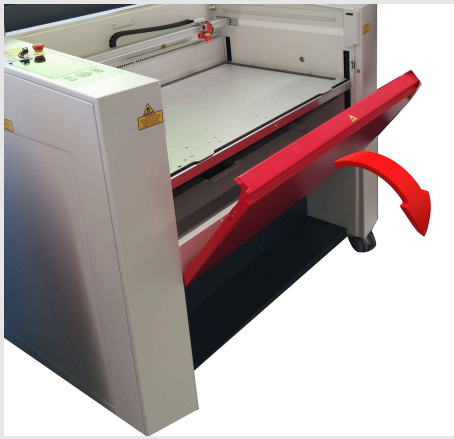

Loading and unloading of heavy and bulky parts or replacement of the table is very comfortable thanks to the front door that can be opened downwards.



Notice

The door is interlocked, therefore it must be closed before any laser operation is possible.

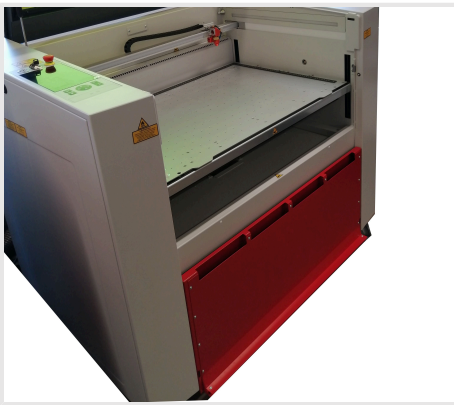

4.4 Tables (multifunctional table concept)

FERROMAGNETIC ENGRAVING TABLE



The ferromagnetic construction allows mounting thin materials such as paper, films or foils with magnets to ensure an even and flat surface. An even working area is essential for achieving optimal results for laser engraving and marking applications.

VACUUM TABLE

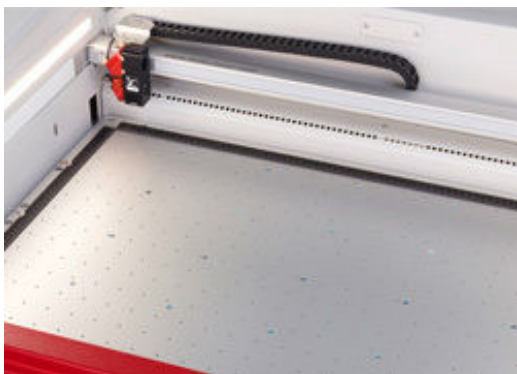

The vacuum table fixates various materials to the working table using vacuum. This ensures correct focusing over the entire surface, leading to better engraving results. In addition, it reduces the handling effort associated with mechanical mounting. The vacuum table is the ideal table for thin and lightweight materials, such as paper, foils and films, that generally do not rest flatly on the surface.

ALUMINUM SLAT CUTTING TABLE



The cutting table with aluminum slats is ideal for cutting thicker materials (8 mm thickness and above) and for parts wider than 100 mm. The slats can be arranged individually, consequently the table can be adjusted to each individual application.

ACRYLIC SLAT CUTTING TABLE



The cutting table with acrylic slats prevents reflection during cutting. This table is used in particular for cutting thicker materials (8 mm thickness and above) and for parts wider than 100 mm. The slats can be arranged individually, consequently the table can be adjusted to each individual application.

ALUMINUM CUTTING GRID TABLE

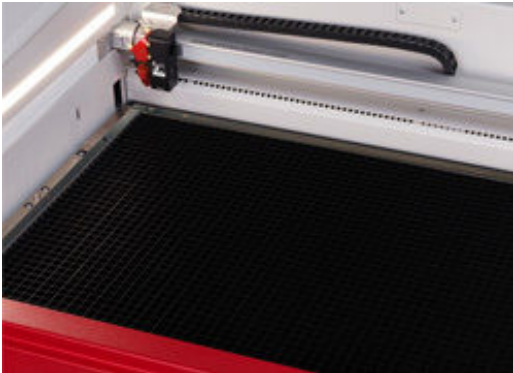

This robust cutting table offers excellent stability and is particularly suitable for cutting tasks with parts smaller than 100 mm, as these remain in a flat position after the cutting

ACRYLIC CUTTING GRID TABLE

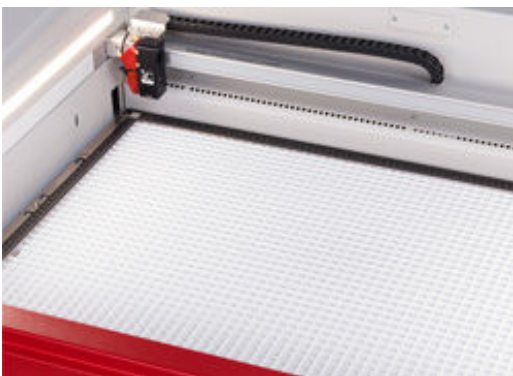

The special acrylic cutting grid table prevents reflection during cutting. It is therefore ideal for cutting acrylics, laminates or plastic films with parts smaller than 100 mm, as these remain in a flat position after the cutting.



Notice

The equipment of the machine may vary depending on the model.

4.4.1 Table placement



1. Place a suitable table on the multifunctional base frame.



2. Fixate the table by pressing the push buttons.



Notice

All table variants rest on the base frame. However the ferromagnetic engraving table may also be placed directly on the mounting frame without the base frame.

Maximum material load is:

- For static loads up to 220 lbs (100 kg).
- For dynamic loads up to 66 lbs (30 kg).



Caution

Damage of the multifunctional base frame or impairment of the exhaust function.

When workpieces are processed directly in the multifunctional base frame without a table, the base frame be damaged, and impairment of the exhaust function is possible.

- Process workpieces only on a suitable and inserted table variant.

HONEYCOMB TABLETOP

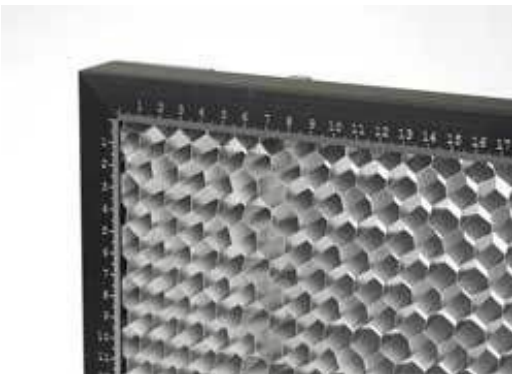

The honeycomb tabletop is especially suitable for applications that require minimal reflection and optimum flatness of the material, e.g. cutting of membrane keyboards.

The honeycomb tabletop is an additional option for the vacuum and ferromagnetic engraving tables.

Available in following sizes:

- 0.5 inch nominal comb size
- 0.25 inch nominal comb size

4.5 Lens(es)

CO ₂		Fiber		Flexx	
	1.5" red Part number: 85973		3.2" green Part number: 1380		2.85" gold (standard) Part number: 9567
	2.0" black (standard) Part number: 85974		5.0" light blue Part number: 37781		
	2.0" CL brown Part number: 95909				
	2.5" silver Part number: 85975				
	4.0" blue Part number: 90026				

**Notice**

The equipment of the machine may vary depending on the model.

4.6 Nozzles



Ø 3 mm

Short nozzle with small hole.



Ø 7 mm

Short nozzle with big hole.

5 Transport

5.1 Safety notes



Warning

Risk of injury

There is risk of injury from falling parts during transport, loading and unloading of the machine.

- Follow the safety notes.

Observe the safety notes to avoid damage to the machine from improper handling during transport:

- Always move the machine with utmost care and attention.
- Transport the machine/machine components only in its original packaging.
- Take the machine's center of gravity into account when transporting it (minimize the risk of tipping over).
- Observe the packaging symbols (e.g. transport the machine only in upright position).
- Take measures to prevent the machine from slipping sideways, tipping or falling over.
- Transport the machine as carefully as possible in order to prevent damage.
- Avoid vibrations.
- When transporting the machine overseas, the device must be packaged airtight and protected against corrosion.
- When transporting outdoors, transport only in vehicles with roof or sufficient weather protection.
- Protect the machine against transportation damage using straps and inserts, and leave sufficient gaps to other transported items.
- Do not place any other loads or items on the machine or machine components.

5.2 Delivery state

Unless otherwise agreed, the machine is delivered in a wooden crate that contains the laser machine and additional accessories. Transport the machine only in its original packaging.



Caution

Risk of injury

There is risk of injury from falling parts during transport, loading and unloading of the machine.

- Follow the safety notes.

OBSERVE THE PACKAGING SYMBOLS:

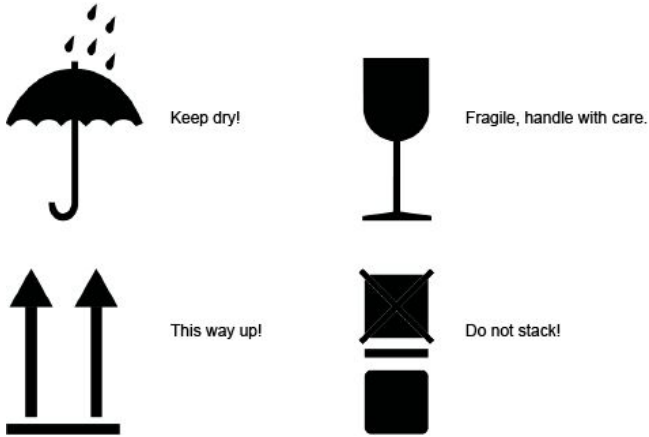

NOTE THE SHOCKWATCH SIGN:

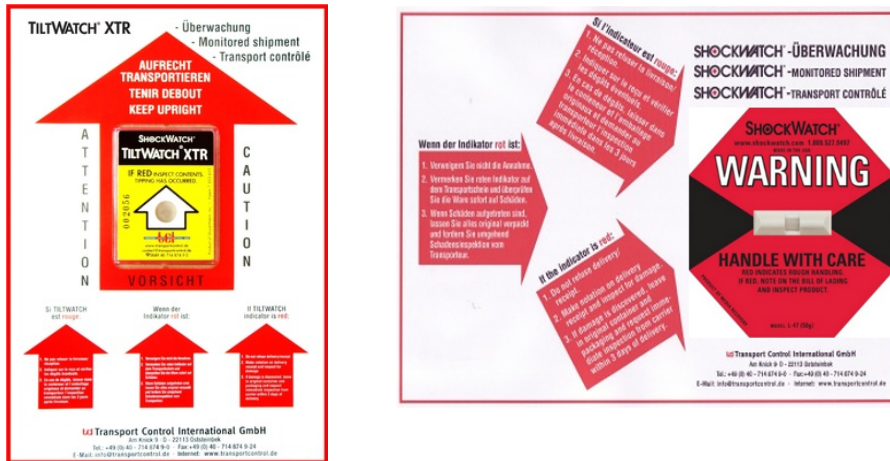

5.3 Temperature and humidity

Transport conditions

Transport temperature (ambiente temperature):	-10 °C to +40 °C (14 °F to 104 °F)
Relative humidity:	Maximum 70%, non-condensing

- Avoid high temperature fluctuations.

Storage conditions

Storage temperature (ambiente temperature):	0 °C to +30 °C (32 °F to 86 °F)
Relative humidity:	Maximum 60%, non-condensing

- Avoid high temperature fluctuations.

5.4 Required tools for unloading and transport

REQUIRED TOOLS:

- Unloading - Forklift
- Transport - Pallet truck

5.5 Place of storage

- Keep the machine sealed in its packaging until it is assembled or installed.
- The storage location must be dry, free of dust, caustic materials, vapors and combustible materials.
- Store in a storage room or packaged with adequate weather protection.
- Avoid exposure of the machine to shocks or vibrations.
- Avoid extreme temperature fluctuations.
- Take particular care when packing away electronic components.
- When storing for a longer period, apply a coat of oil to all bare-metal machine parts.
- Regularly check the overall condition of all parts and of the packaging.

5.6 Transport inspection and reporting of defects

- Immediately after receipt inspect the delivery to ensure that it is complete and has not suffered any damage.
- If any transport damage is visible, do not accept the delivery, or accept it only with reservation.
- Record the scope of the damage on the transport documents or delivery note.
- For all defects that are not discovered upon delivery, be sure to report them as soon as they are detected, since damage claims must be filed within a certain period, as mandated by law.

5.7 Unpacking the machine

Only trained and authorized personnel are permitted to transport and unpack the machine. To avoid falling off of any wooden parts or tipping of the machine, be very careful when opening the transport case.



Notice

Keep the original packaging case, in case of machine needs to be transported or relocate.

Dispose all waste according to the applicable waste disposal law.



Caution

The lens unit should be unpacked only after installation of the machine. The lenses are high-quality optical components which must be kept clean in order to ensure optimum marking results. Never touch the lenses with bare fingers.

STEPS:

1. Position the transport case vertically on level ground (using a pallet truck or forklift).
2. Remove any vertical tightening straps.
3. First remove the top and afterwards the side plates of the transport case.
4. Slide out the two wooden rails in the form of ramps that are stored beneath the machine.
5. To secure the machine against moving, the wheels are locked using wooden blocks.
In order to remove those blocks, put the two wooden rails together, push the upper part of the rails under one side of the machine and press down the rail in order to reach a levering effect.
6. Pull out the blocks.
7. Repeat this procedure on the opposite side as well.
8. Now you can pull out the blocks.

5.8 Relocation of the machine

STEPS:

1. Switch off the machine.
2. Disconnect the power cable.
3. Remove the exhaust system.
4. Reposition the machine (e.g. with auxiliary equipment if necessary) and place it on a level, clean floor.
5. Adjust the machine.
6. Initial commissioning of the electrical system.
7. Carry out function test.



Caution

Transport the machine only in its original packaging. Ensure the wooden crates are properly secured otherwise the crates can slip, tip or fall over during transport.

Observe the corresponding safety norms and regulations from the chapters "Safety notes" and "Transport".

- When transporting over long distances, use transport boxes including transport securing.



Notice

If you would like to relocate the machine, contact our experienced Technical Support in your local area.

6 Setup and installation

6.1 For your safety



Notice

The setup has to be carried out by Technical Support.

6.2 Temperature and humidity

Ambiente conditions

Operating temperature (ambiente temperature):	+15 °C to +25 °C (59 °F to 77 °F)
Relative humidity:	45% to 65%, non-condensing

- If the system has been exposed to large temperature fluctuations, it must first be brought back to room temperature before commissioning.

ENVIRONMENTAL CONDITIONS

- Provide sufficient illumination at the workplace.
- Ensure a dust-free environment (II° according to IEC60947-1).
- Shielding from EMC.
- Freedom of interfering electrical installations, hoses and pipe lines.
- Power supply free of fluctuations.

6.3 Space requirements

Ensure there is shielding or sufficient clearance to or from the wall and neighboring objects.

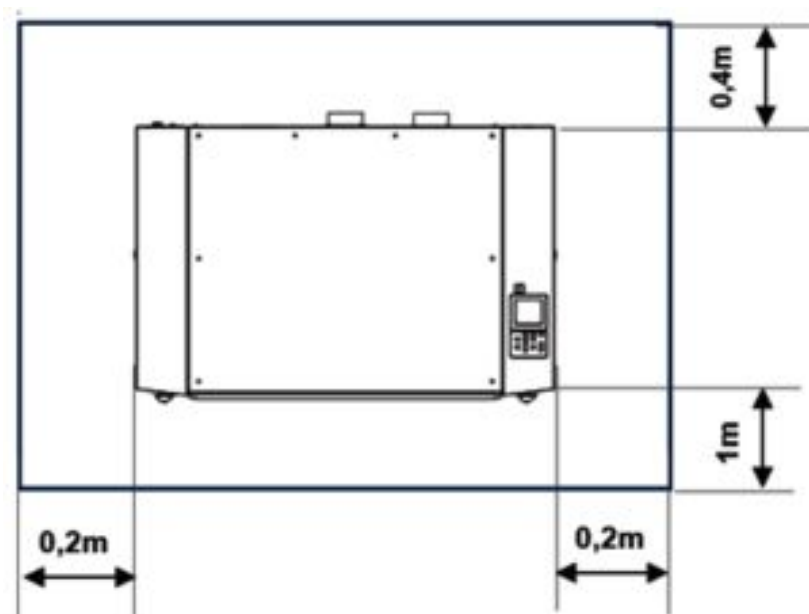

6.4 Setup

OBSERVE THE FOLLOWING STEPS:

1. Transport the machine to the installation location according to the specifications stated in the chapter "Transport".
2. Make sure all the packaging material has been removed.
3. Remove any transport protections.
4. Install the two exhaust connectors at the rear of the machine.
They have been removed for safety reasons and for transport through doors.
5. The machine must stand upright.
6. Make sure the protective glass is intact.
7. Now connect the electrical components.
8. Set up the network connection to the machine.



Caution

Install the connections exactly in the order described, otherwise electrostatic charging can damage your computer and/or the electronics of the laser system.

6.5 Connections

6.5.1 Mains connection

Connect the end of the mains connection cable to the main connection socket.



Warning Dangerous electrical voltage

Wrong voltage can cause damage to the machine.

Do not operate the machine, if the mains voltage does not match the voltage required by the exhaust system, as this may cause damage to the machine.

Make sure that the mains voltage matches the voltage required by the exhaust system.



Notice

Depending on the laser power and region, the main fuses are either covered or open on the back of the machine.

7 Connection of additional components

7.1 Exhaust system



Warning Dangerous electrical voltage

Wrong voltage can cause damage to the machine.

Do not operate the machine, if the mains voltage does not match the voltage required by the exhaust system, as this may cause damage to the machine.

Make sure that the mains voltage matches the voltage required by the exhaust system.

Connecting:

1. When using an original Trotec exhaust system, also connect this, using the exhaust connection cable included, to the exhaust cable connection on the laser.
2. Plug the ends of the exhaust hose into the exhaust nozzle that is intended for this purpose on the exhaust system and on the laser. The position of the connector depends on the type of the exhaust system.
3. Plug in the mains cable of your exhaust system into the mains socket.

Follow the operation and maintenance instructions in the Manual of the exhaust system.

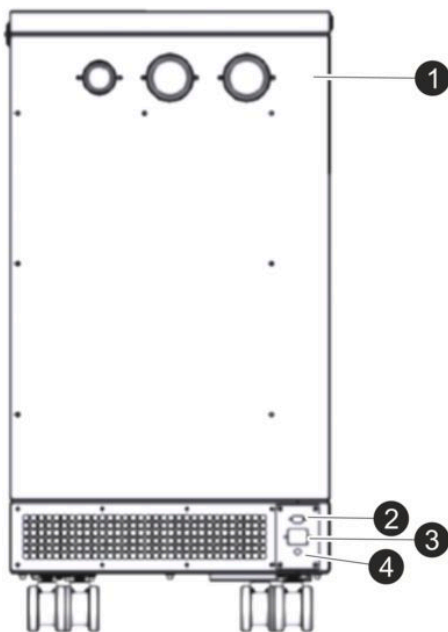

- ① Intake connector for exhaust hose
- ② Connector for exhaust connection cable
- ③ Main cable to main socket
- ④ Safety switch

7.2 Chiller

WATER COOLING UNIT (CHILLER)

When using water-cooled laser sourced, a cooling unit is required. The mixture of distilled water and special additives protects and prevent the formation of algae and limescale deposits in the cooling unit and laser source. This ensure operation and longevity of the laser cooling unit and laser source

MIXTURE

Distilled water and the additive *Watertreatment-Kit 480-WTK-10.88.



Caution

Do NOT use glycol-containing additives!

FILLING AND WATER REPLACEMENT

Fill the cooling unit with distilled water and add the additives (the kit is pre-dosed and a safety handling manual is included).



Notice

The conductivity of the water must not exceed 1000 μ S. This value will not be reached if mixing the distilled water and additive accurately. A conductivity meter is available on request from Trotec Laser GmbH.

Water replacement must be carried out once a year. Empty the cooling unit, clean it with distilled water, fill it with fresh distilled water and add new additives.



Notice

In case of extremely strong impurities the additive *Nalco CCL2567 is recommended for the cleaning rinse.

*** ORDER ADDRESS FOR ADDITIVES:**

CTA GmbH

Voithstraße 1

71640 Ludwigsburg / Germany

E-mail: service@cta-gmbh.de or slund@nalco.com

Order number water treatment kit: Watertreatment-Kit 480-WTK-10.88.

Order number cleaning rinse: Nalco CCL2567

8 Operation



Warning

Personal injury or damage to property due to improper operation.

Improper operation can lead to serious personal injury or damage to property.

- Work on the laser machine may only be carried out by authorized and instructed personnel familiar with the operation of the machine, observing all safety regulations.

8.1 Before commissioning

CHECK THE FOLLOWING POINTS BEFORE COMMISSIONING:

- Completeness and technically flawless condition of the machine and safety devices.
- Order and cleanliness at the workplace.
- Cleanliness of optical components (free of dust and dirt).
- Activated exhaust system.
- Complete electrical installation.
- Correct input voltage of the electrical installation.
- Environmental conditions according to technical specification.
- Compliance with all laser safety regulations and measures.
- Fulfill and compliance with all laser safety requirements according to chapter 2.

If errors or functional deviations should occur during the inspection of the listed points, the machine is not considered to be safe to operate and must not (no longer) be put into operation until the fault is corrected.

If you have any questions, contact our experienced Technical Support in your local area.

8.2 Power On/Off



Notice

In order not to restrict or obstruct the freedom of movement of the mechanics, no objects of any kind may be located in the machining area.

All safety protection covers have to be fully functional and closed.

SWITCH ON:



1. Switch on the main power supply using the main switch on the rear of the machine.

The built-in Ruby server starts.



2. Turn the key switch to the right into the vertical position to activate the touch display.

To start the machine, turn the key switch to the right and hold it against the spring force. As soon as the machine starts, release the key switch.

3. Referencing process starts.
4. As soon as the reference run of the axes is completed, a signal tone sounds.
5. The device is ready for operation as soon as Ruby is fully started.



Notice

Additionally the ready-to-use state is indicated through the slow flashing of the green status LEDs.

SWITCH OFF:



1. Turn the key switch to the left.

The touch display switches off, the axes are de-energized and the server remains active.



2. Switch off the main power supply to the machine by operating the main switch on the rear of the machine.

8.3 Control panel

The control panel is the whole unit of the machine control.

The soft buttons on the touch display and the keypad are components of the control panel.

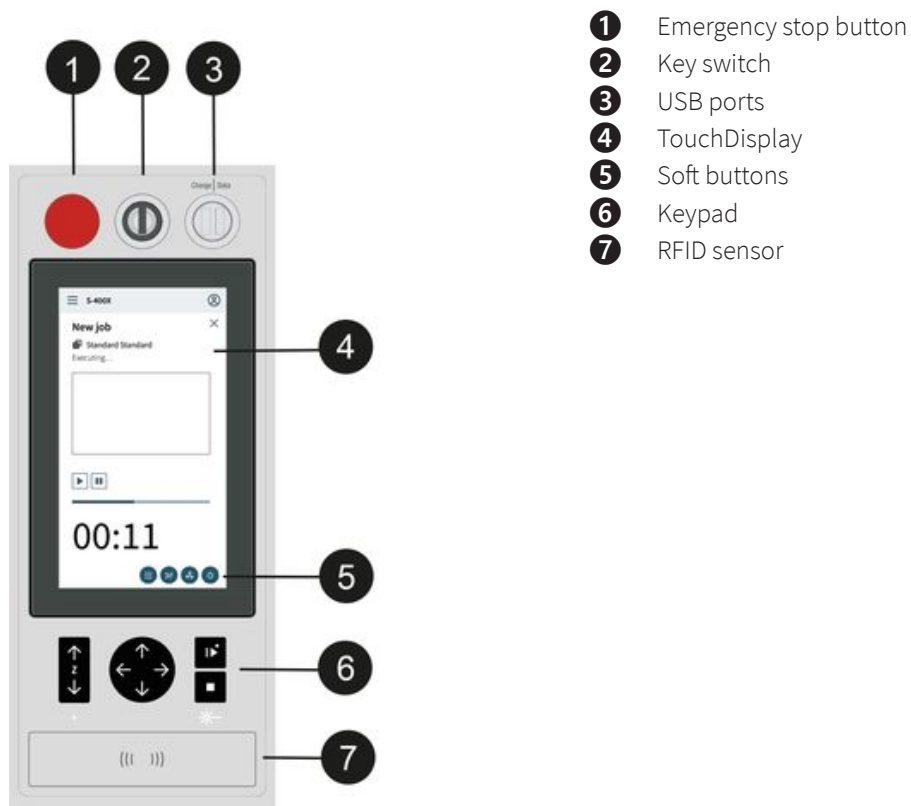

8.4 Soft buttons on the touch display

With the soft buttons on the touch display you can:

- call up the jobs in the queue
- switch on the air assist
- switch the exhaust system on and off
- and set the laser machine to standby mode.

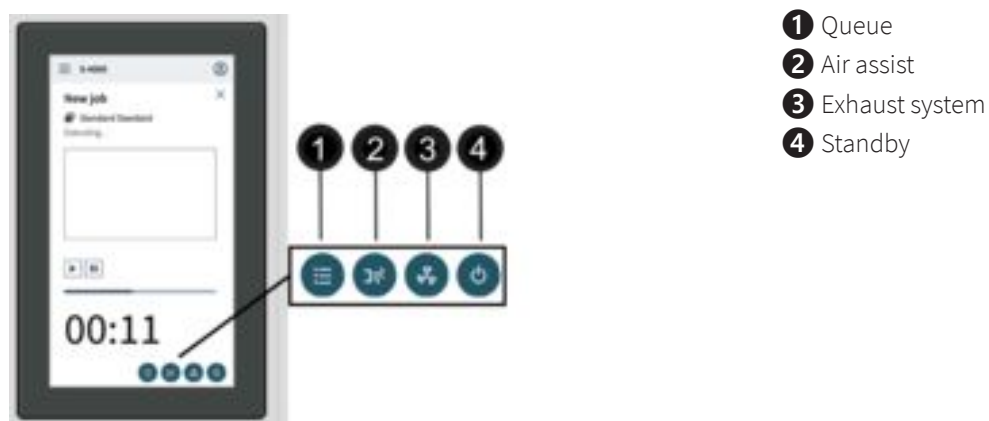

8.5 Keypad

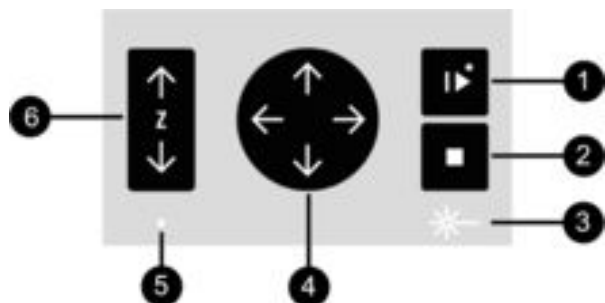

① Start/Pause/Repeat-button

② Stop-button

③ Status indicator LED On: The machine is processing data.

④ Laser head control button X/Y

- travel distance in X-direction
- travel distance in Y-direction

⑤ RFID-Control display

⑥ Working table control button Z

- Up-button
- Down-button
- Automatic focusing



Start/Pause/Repeat-button

Start:

- Press this button to start a job.

Pause:

- Press this button to pause the job which is currently being processed.
- Press this button again to continue the job.

Repeat:

- Press this button after a job was finished to repeat the actual job.

Meaning of the LEDs:

LED	Description
Green, flashing slowly (0.5 Hz)	All covers are closed. Machine is ready.
Green, flashing fast (2 Hz)	Minimum one cover is open.
Blue + Green, permanent	Data available. Pause-mode active.
Green, permanent	Job is running. Processing and receiving data.



Status indicator

LED On: The machine is processing or receiving data.



Laser head control button X/Y

- Press one of these buttons to manually move the laser head to the right, left, front or back (travel distance in X/Y-direction).
- Press two of the for Laser head control buttons X/Y simultaneously in diagonal direction to move the laser in diagonal direction (X+/Y+, X+/Y-, X-/Y-, X-/Y+).

**Working table control button Z**

- Press one of these buttons to manually move the working table up or down (travel distance in Z-direction).
- By simultaneous pressing of the Up-button + Down-button, the activation of the automatic focusing starts and the working table is moving automatically upwards.

Press any button in X-, Y-, or Z-direction to stop the automatically movement.

Activation of the automatic focusing:

The laser beam gets automatically focused on the work piece (depends on the selected lens). When there is no work piece on the working area, the focus is on the table or rather on the tabletop.

Sonar Technology™:

Focusing on the material which is below the sensor.

**Caution**

If there is no material on the cutting table, it could lead to a collision of the laser head ("head crash").

**Stop-button**

- Press this button to stop the current working process.

8.6 USB ports

There are two USB ports on the control panel.



Charge (max. 2A) = Charging port
Data (500mA) = USB port (USB stick, HDD,..)

8.7 Lense placement

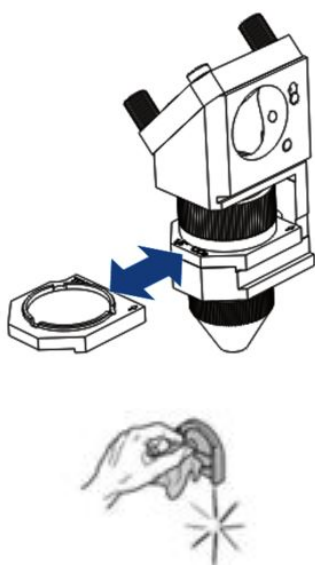

1. Loosen lens by turning the clamping ring inwards.
2. Remove lens.
3. Check the lens for damage.

4. If necessary, clean both sides of the lens with cleaning liquid and cleaning tissue.

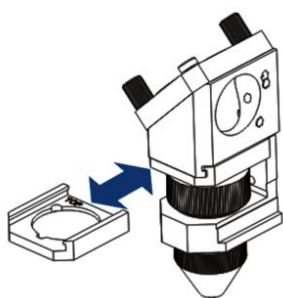

5. Insert the lens with the lettering facing up, either above or below the clamping ring depending on the lens type.
6. Fixate the lens with the clamping ring.

THE FOLLOWING LENSES MUST BE INSERTED BELOW THE CLAMPING RING:

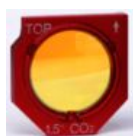

1.5"



2.0"



Notice

All other available lenses must be inserted above the clamping ring.

8.8 Focusing methods

Precise laser engraving depends on several factors. Apart from the right choice of lens, working tables and a corresponding exhaust system, correct focusing plays a key role.

The correct setting of the focus, which means the right distance between the laser head and the material to be engraved, is crucial for a perfect application result.

Manual focus mode

- Focus tool

Automatic focus mode

- Sonar Technology™ (automatic focusing with ultrasonic sensor)



Caution

If workpieces with more than 66.14 lbs (30 kg) have been placed on the table, the table must not be moved up or down anymore as this might damage the mechanics of the machine.

It is mandatory to focus on the height of the material before loading material of 66.14 lbs (30 kg) and above.



Notice

Defects from head crashes (working head hits material or working table) are excluded from warranty.

8.8.1 Focus tool

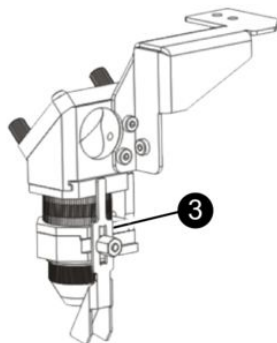
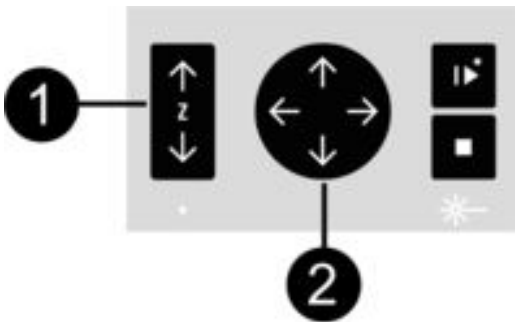

1. Move the processing head over the material to be engraved by means of the Laser head control button X/Y (2) on the keypad.
2. Hang the focus tool (3) on the allocated space on the laser head so that the focus tool can move unhindered.
3. Move the working table upward by pressing and holding the working table control button Z (1). Observe the focus tool closely to avoid a collision with the working head and release the key in good time.
4. Before the focus tool reaches the work piece, move the working table upwards very slowly and step by step by briefly tapping the Working table control button Z (1) until the focus tool tilts to the side or falls off its position.

Now the lens is focused onto the surface of the material.

8.8.2 Sonar Technologie™

**Caution**

If the ultrasonic sensor is heavily soiled, the laser head may be damaged if it therefore hits the material or the worktable.

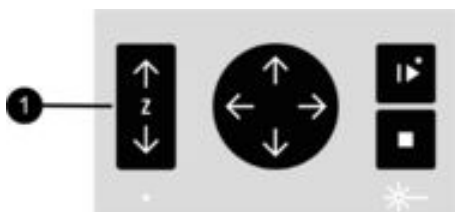

1. Make sure that the ultrasonic sensor is cleaned.
2. Select the correct lens in the control software settings.
3. Move the laser pointer over the workpiece to the surface to be focused.
4. Simultaneously press the two keys of the working table control button Z (1) so that the working table automatically moves to the focus position and the laser beam is focused on the workpiece.
5. Focusing completed and laser processing can begin.

**Notice**

This focusing mode is especially well-suited for all sound-relective materials.

8.9 Options

8.9.1 Rotary attachment

The Rotary attachment is used to engrave cylindrical workpieces.



Caution

Damage to electronics.

Inserting or removing the Rotary attachment while the machine is turned on may irreparably damage the electronics.

Switch off the machine before inserting or removing the Rotary attachment.

Rotary attachment with cones:

Max. workpiece diameter: 8.1 inch (207 mm)

Max. workpiece length cones: 21.6 inch (550 mm)

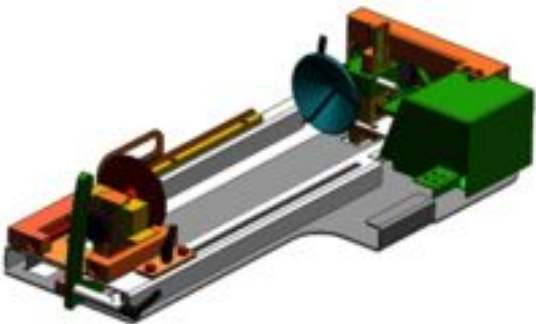

Rotary attachment with cones

Rotary attachment with rolls:

Max. workpiece diameter: 3.8 inch (96 mm)

Max. workpiece length:

$\text{Ø} \geq 2.2 \text{ inch (58 mm)} = 26.7 \text{ inch (679 mm)}$

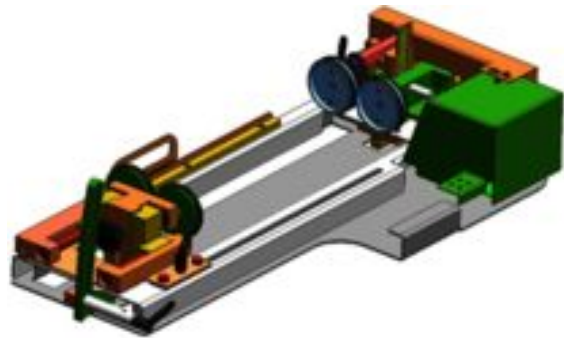

$\text{Ø} \leq 2.2 \text{ inch (58 mm)} = 29.3 \text{ inch (745 mm)}$



Rotary attachment with rolls

8.9.2 Rotary engraving process

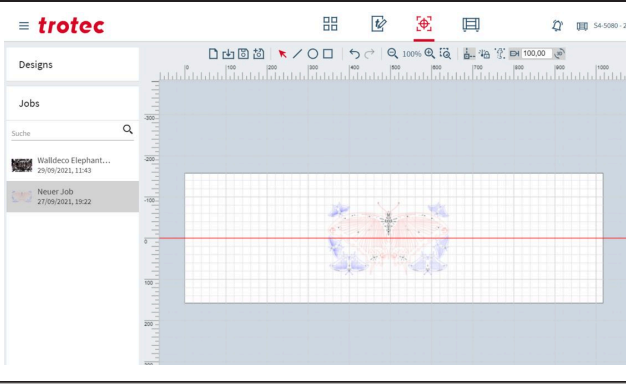
1. Create a graphic using the graphics software.	
2. Select the Rotary engraving option from the menu bar and specify the diameter of the item.	

<p>3. Select the job from the list and place it in the marking field.</p>	
<p>4. Start the engraving process.</p>	

8.9.3 Installation and commissioning

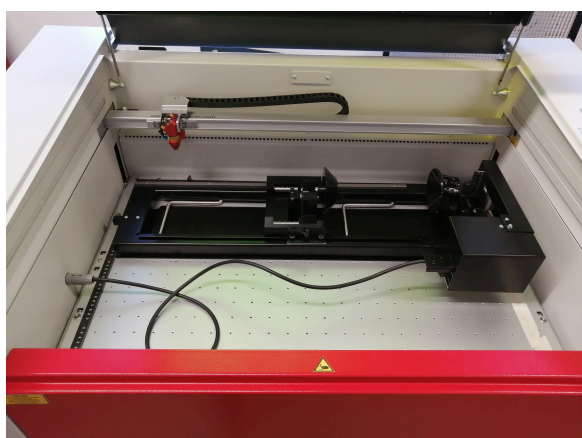

1. The machine must be switched off.



Warning Dangerous electrical voltage

If the rotary attachment is connected during operation, the connections and the electronics will be damaged. Such damage is excluded from the warranty.

1. Place the rotary attachment on the base frame to the ruler using the insertion handles.
2. Connect the device with the connecting cable via the connector on the left side of the housing.

8.9.4 Mounting the work piece in the rotary attachment

1. Measure the diameter of the workpiece.
2. Adjust the height and angle of the system by loosening and fixing the levers.

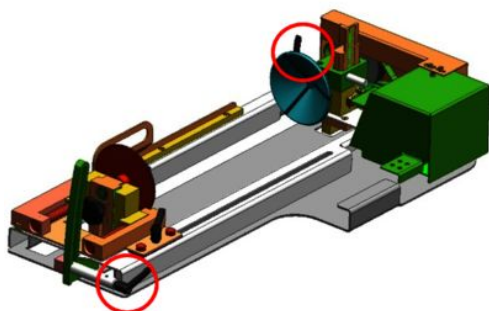

Levers for fixation of height and angle

3. Loosen the slider by using the lever in order to clamp the workpiece between the two cones or rolls.

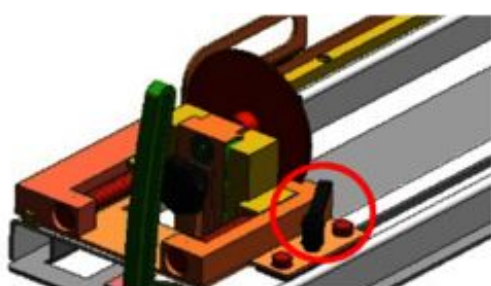

Slider inclusive lever

4. Switch on the laser. The axis automatically moves over the middle of the rotary attachment.
5. Position the laser head over the workpiece at the position where you want to engrave.
6. Focus the object with the focus tool. The engraving area must be parallel to the X axis. If necessary, do this with the aid of the angle adjustment. Do not touch the lens holder.

8.9.5 Temperature sensor

The temperature sensors ensure reliable temperature monitoring of the interior of the machine and are available as additional option.

If a preset temperature value is exceeded, an acoustic alarm continuously sounds to warn the operator of abnormal temperature trends during processing.



Warning **Fire hazard**

The acoustic alarm upon startup of the machine indicates that the sensors are operating properly. However, the sensors do not guarantee fire prevention.

- The unit must not operate unattended despite the integrated temperature sensors.
- If the acoustic alarm does not sound when the machine is switched on, check the functionality of the sensors.
- In case of questions, contact our experienced Technical Support in your local area.

TEMPERATURE SENSOR ALARM ACKNOWLEDGEMENT



Press any key on the keypad to acknowledge the alarm.



Notice

The signal tone sounds again and again until the temperature returns to normal. Alternatively, switch off the laser system and check the temperature sensors.

8.9.6 Trotec Vision Print&Cut



Information

The camera must be calibrated during installation and regularly afterwards. For more information, see the online software manual.



The Vision option is a camera on the laser processing head that reads the registration marks on the plate material, thus detecting and compensating for distortions in the print. The material is cut for an exact fit. Production times are accelerated and cost-intensive miscuts are avoided.



In the control software, under the settings tab, the camera option must be checked to adapt the acceleration and travel to the weight on the processing head.



Notice

When the camera is removed, the hook can be removed to return the speed and travel distance to maximum.

8.9.7 Vision Design&Position

Camera-assisted design and positioning directly on the workpiece live in Ruby®, whether the lid is open or closed. This allows the user to see a visual representation of the laser job on the workpiece in the laser software - "What You See Is What You Get" (WYSIWYG). Vision Design&Position is therefore very well suited for small series and residual materials can be better and more easily utilized.



LIVE IMAGE IN RUBY®

After the camera is activated, you will get the live image of the entire workspace.

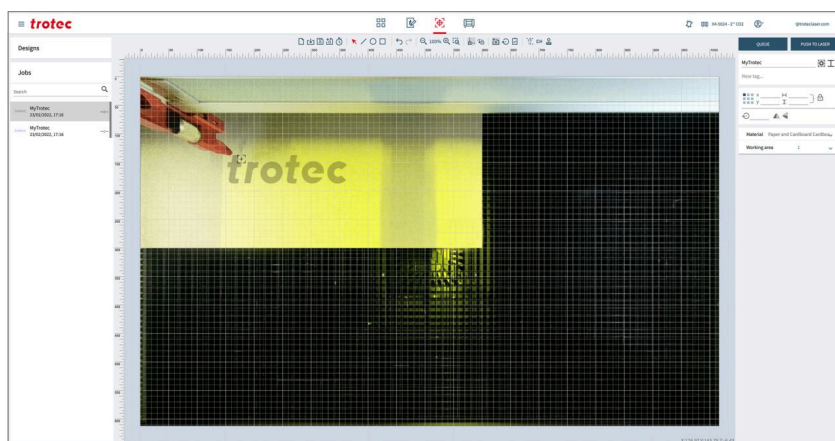

In Ruby® you can work directly on the workpiece:

- set a text
- design a graphic
- or align an existing job accordingly.



Notice

The camera image must be calibrated for each lens distance used. This is done in the settings of the laser software Ruby®.

SETTING CIRCULAR POLARIZATION FILTER

With the help of the circular polarization filter, you can set a stronger image contrast or suppress disturbing reflections as well as back reflections.

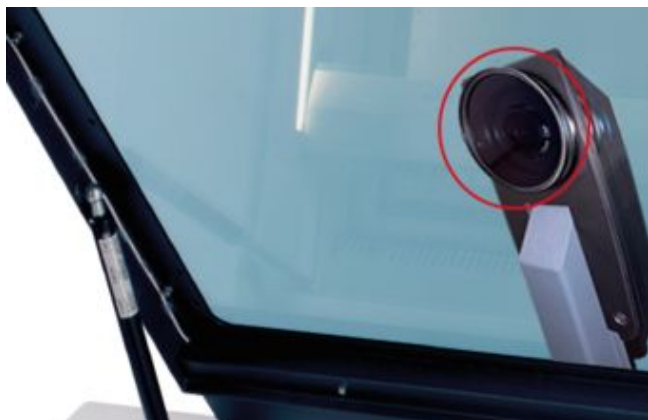

- Vision Design&Position must be enabled in Ruby®.
- Use the live image to make the adjustments.
- To do this, turn the lower ring of the polarization filter until the desired result is achieved.

9 Maintenance

9.1 Safety notes



Danger

Improper maintenance can cause serious injury or damage.

Maintenance may be carried out only by authorized, trained personnel who are familiar with how to operate the machine and in strict observance of all safety notes.



Danger

Risk of fire or explosion.

Improper handling of the machine may cause fire or explosion.

- For cleaning the machine, do not use explosive or flammable substances or cleaning agents.
- No flammable or explosive liquids may be stored in or near the machine.
- Always keep the system clean, and remove flammable parts from the working area or exhaust area.



Warning Dangerous electrical voltage

Danger of electrical shock.

Work on electrical fittings may be carried out only by qualified personnel and in strict observance of the safety notes.

Before any maintenance work takes place, disconnect the machine from the mains voltage and make sure the system is de-energized.

IMPORTANT NOTE ON MACHINE SAFETY:



Notice

The safety devices of the laser system must be replaced due to component aging or corresponding (e.g. > 72,000 lid cycles / anno), the safety equipment of the laser system must be replaced by an authorized technician after 10 years at the latest, otherwise safety can no longer be guaranteed. Without measures, the operating license will expire.

9.2 Maintenance plan

System Components	Daily	Weekly	Half-yearly	Yearly
Lens, mirror #4	✓✓			
Mirror #2 and mirror #3			✓✓	
Ultrasonic sensor (option)	✓✓			
Working table and rulers.	✓✓			
Vent slots of exhaust box. (inside the machine)	✓✓			
Entire working area. General cleaning.		✓		
Energy Chain x-axis		✓		
Vent slots (backside of the machine)			✓✓	
Spindles				Clean and grease.
Cover of the laser source and housing.		✓		

✓✓ Check and clean whenever required.

✓ Clean whenever required.



Notice

In order to ensure the maximum availability and lifetime of the system, we recommend that you regularly check the filter, ventilation and exhaust slots and keep the surrounding area clean. A visual inspection of the lenses is likewise recommended before switching on the system.

9.3 Daily inspection of the safety circuits

BEFORE STARTING WORK:

Checking the safety switch:

1. Open the lid after referencing
 - The LED on the keyboard's Start button should be flashing quickly (2 Hz)
2. Close the lid
 - The LED on the keyboard's Start button should be flashing slowly (0.5 Hz)

→ Check completed

Checking the emergency stop button:

1. Press the emergency stop button
 - Interior lighting is switched off
 - LEDs on the membrane keyboard are switched off
 - Axes are freely movable
2. Release the emergency stop button
 - Machine must be restarted using the key switch

→ Check completed

9.4 Cleaning

9.4.1 Machine

1. Move the working table into a position in which it is easiest for you to clean the surface with a window cleaning agent and paper towels.
2. Switch off and disconnect the machine from the mains.
3. Open the transparent acrylic top lid and front panel.
4. Thoroughly remove all loose dirt particles and deposits in the interior of the machine (e.g. with a vacuum cleaner or broom).
5. Clean the air guide plate and vent slots of the exhaust box inside the machine using a dry or damp cloth or brush.
6. Clean the cover of the laser source and vent slots at the back of the machine using a dry or damp cloth.
7. Clean the transparent acrylic top lid using a dry or slightly damp cotton cloth. Do not use paper towels as they could scratch the acrylic.

9.4.2 Optics in general

Trotec Laser GmbH recommends to use the cleaning set enclosed. Alternatively, use high-quality cotton swabs together with the provided cleaning liquid.



Notice

The following cleaning products are available as accessory parts:

- Lens cleaning cloth
- Lens cleaning liquid

9.4.3 Lens



Warning

Damage to optics.

Soiled optics absorb laser radiation and can thus be destroyed. Broken or damaged lenses as well as thermal decomposition of lenses release particles which cause serious damage to the health.

- The passive reflectors and optics in the area of the laser beam guidance should be cleaned regularly.
- Special care is required when handling, attaching and cleaning these elements.
- Do not exert non-uniform pressure.
- Do not use tools or hard objects to clean the surface.
- Never touch the optics with your bare fingers.
- Never use cleaning tissues twice.
- When lenses get broken, damaged or thermal decomposed follow the protective measures.
- Disposal according to regulations and laws valid in the user's country.
- Lenses with scratches or penetrations must not be used anymore.

STEP1: PREPARATION

1. Blow away loose particles and dust by means of bellows/bellows or compressed air (according to ISO 8573:2010 class 1).
2. Get the cleaning liquid and cleaning tissues ready.
3. Move the table up and put a cloth under the lens holder (so that the lens will not be damaged if it falls out of holder by accident).
4. Loosen the lens by screwing the clamping ring inward.
5. Now remove the lens and check the surface.



STEP 2: CLEANING WITH CLEANING LIQUID AND CLEANING TISSUES

1. Remove the lens and rinse it with cleaning liquid to wash away coarse soiling.
2. Put some cleaning liquid onto the lens and leave the liquid for 1 minute to take effect.
3. Soak a cleaning tissue with cleaning liquid and carefully wipe off the surface.
4. Now carefully insert the lens with the lens holder into the laser head and fixate the clamping ring.



Notice

Trotec Laser GmbH recommends to use the following cleaning products, which are available as accessory parts:

Lens cleaning cloth (part number 69249) and lens cleaning liquid (part number 69248).

9.4.4 Cleaning the mirrors



Caution

Make sure that you do not touch the mirror with your fingers, since this would greatly reduce the service life of the mirror.

Do not touch the mirror with your fingers or with tools, and never use a cleaning tissue twice, as the surface could easily be scratched.

CLEANING THE MIRRORS #2 AND #3

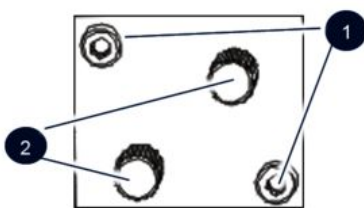

SpiMirror #3

1. For cleaning of mirrors #2 and #3, you must first remove the right maintenance panel.
2. Do not remove the mirror #2. It must remain in the machine for cleaning.
3. The mirror #3 is attached by means of two Allen screws (1), which are located on the mirror holder. Open the screws and remove the lens holder together with the mirror.

Do not touch the milled screws (2) while doing this!

4. Flush the mirror with cleaning liquid to wash away coarse soiling.
5. Put some cleaning liquid onto the mirror and leave the liquid for 1 minute to take effect.
6. Soak a cleaning tissue with cleaning liquid and carefully wipe off the surface.
7. Now carefully put back the mirror and fixate it with the two Allen screws.

CLEANING THE MIRROR #4

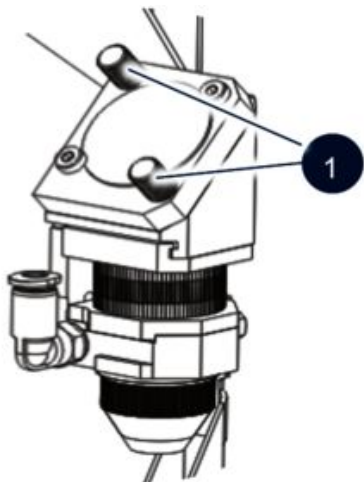

1. While holding the mirror, loosen the two knurled screws (1) and lift the mirror from the mirror holder.



Caution

Make sure that the mirror does not grind over the mirror holder, as it can be scratched very easily.

2. Flush the mirror with cleaning liquid to wash away coarse soiling.
3. Put some cleaning liquid onto the mirror and leave the liquid for 1 minute to take effect.
4. Soak a cleaning tissue with cleaning liquid and carefully wipe off the surface.
5. Now carefully re-insert the mirror and fixate it with the two knurled screws.

Mirror #4

9.4.5 Ultrasonic sensor (Sonar Technology™)

The sensor can be cleaned either with a brush, or be wiped drily, with moisture or with mild detergents and a microfiber or anti-statics cloth. In case of stronger soiling, isopropyl or ethanol solution can be used.

Avoid long application time and long-term usage.

10 Troubleshooting

This chapter should enable the maintenance personnel to identify and resolve operational faults based on error messages and symptoms.



Warning

Risk of fire from incorrect parameter settings.

Laser operation with incorrect parameter settings such as power settings, speed or frequency can result in flame formation.

- Laser operation permitted only under supervision.



Caution

System failures that cannot be remedied can cause damage to the machine.

- Disconnect the machine from the mains and contact your local Technical Support.

10.1 Error, cause and remedy

Problem	Possible cause	Remedy
Too low engraving depth.	<ul style="list-style-type: none"> • Imprecise focusing. • Dirty optics. 	<ul style="list-style-type: none"> • Check focus. • Clean optics.
Blurred edges.	<ul style="list-style-type: none"> • Imprecise focusing. 	<ul style="list-style-type: none"> • Check focus.
Missing cut lines.	<ul style="list-style-type: none"> • Zero passes in material database. • Line thickness in CorelDraw too big. • Color was skipped in the software. 	<ul style="list-style-type: none"> • Increase the amount of passes in the material database. • Reduce line thickness to the smallest possible value. • Set color to cutting in the database.
Waviness of the lines.	<ul style="list-style-type: none"> • Lens is loose. 	<ul style="list-style-type: none"> • Check lens and lens holder.
No visible marking result.	<ul style="list-style-type: none"> • Too low laser power. • Too high speed. • Not focused. • Wrong focus tool. 	<ul style="list-style-type: none"> • Increase power setting. • Reduce speed. • Check focus. • Change focus tool. • When using autofocus, check the settings within the software (lens, material thickness, table).
Fine details on stamps are engraved too thinly.	<ul style="list-style-type: none"> • Too steep shoulders. 	<ul style="list-style-type: none"> • Choose other shoulder or edit (flat/medium/steep): Options/Process Options/Stamp.

Problem	Possible cause	Remedy
The size to be engraved or cut does not match the size in CorelDraw.	<ul style="list-style-type: none"> • Raster correction ON in the software. • Wrong size settings in the printer driver. • Wrong image position is selected in the layout tab (printing). • Wrong machine is selected in the software. 	<ul style="list-style-type: none"> • Switch off raster correction in the software (settings/advanced options/laser tab). • Use the same size as in CorelDraw. • Switch the layout settings to: as in document. • Select the proper machine in the software.
Corners and angles are not cut or marked.	<ul style="list-style-type: none"> • Power too low. 	<ul style="list-style-type: none"> • Increase the correction in the software (Settings / Material Templates Setup - Correction).
No referencing after comissioning.	<ul style="list-style-type: none"> • Top, front or side door not closed. 	<ul style="list-style-type: none"> • Close doors.
No response upon switching on of the system.	<ul style="list-style-type: none"> • Fuse blown. • No electric power at power outlet. 	<ul style="list-style-type: none"> • Check fuses. • Check power outlet.
No communication with machine.	<ul style="list-style-type: none"> • Invalid COM port selection. • Communication cable defect. • COM: port is in use by another program. 	<ul style="list-style-type: none"> • Change selection. • Check cable. • Close this program, or change the COM port.
Connection to machine frequently interrupted.	<ul style="list-style-type: none"> • Electromagnetic emissions. 	<ul style="list-style-type: none"> • Make sure that machine and computer are connected to the same electric circuit; the original cable lengths should not be exceeded.
Offsets between engraving jobs and cut lines.	<ul style="list-style-type: none"> • Speed too high. 	<ul style="list-style-type: none"> • Reduce speed.
Errorcode 124	<ul style="list-style-type: none"> • Interlocks open during the referencing process. 	<ul style="list-style-type: none"> • Restart the machine (key switch).
Other faults.		<ul style="list-style-type: none"> • Contact Technical Support.

11 Contact details

TECHNICAL SUPPORT

In case of questions, contact our experienced Technical Support in your local area.

For global service contact numbers and further information please see our website, section "Support":

www.troteclaser.com

When calling, please make sure that the machine is in your immediate vicinity, and that you have the following information ready (see response form):

- At which working process did the problem occur?
- What you have done so far to correct the problem.
- Serial no (see type plate).
- Error code.

LOCAL OFFICES / SALES

Our store locator and detailed information on our offices in your area can be found on our website in section "Contact", "Local Office": **www.troteclaser.com**

TECHNICAL DOCUMENTATION

For feedback or to suggest changes to this manual, contact:

Technical documentation: +43 (0) 7242 239 - 7000

E-Mail: **technical.documentation@troteclaser.com**

12 Disassembly



Warning

Danger of injury when disassembling the machine.

There is danger of injury when disassembling the machine.

Always wear suitable protective clothing (e.g. safety goggles, safety shoes, safety gloves).



Warning Dangerous electrical voltage

Electric current.

The machine must be disconnected from the main power supply.



Notice

- Always use suitable tools to disassemble the machine.
- Mind the springs.
- Follow chapter "Disposal".

PROCESS:

1. Remove all workpieces from the system.
2. Turn the key switch to switch off the machine.
3. Switch off the main switch at the back of the machine.
4. Remove the exhaust system.
5. Disconnect all cables at the back of the machine.

13 Disposal



Disposal

Do not dispose of the machine with domestic waste!

Electronic devices have to be disposed of according to the regional directives on electronic and electric waste disposal.

In case of further questions, please ask your supplier.

In case of disassembly, use suitable tools to dismantle the unit into individual parts. Sort the individual parts and have them disposed of professionally. Legal regulations must be adhered to.

14 Appendix

Acceptance report

Dear customer!

We request your confirmation of properly completed transfer of the machine. Please transmit a copy of this document - filled out and signed by an authorized company representative - to an employee of our sales affiliate for forwarding to the manufacturer.

Please check applicable items:

- Machine parts checked for shipping damage.
- Machine parts checked against delivery note.
- Setup of the machine discussed.
- Startup of the machine discussed.
- Operation of the machine discussed.
- Maintenance of the machine discussed.
- Electrical voltage checked.
- Safety notes discussed.
- Trial run performed.
- Deficiencies determined.

The machine with the machine designation:

has been checked according to the listed items and has been handed over properly.

City, Date

(Instructed person)
Name, Position

Company stamp, Signature

Training verification form

Trainee: _____

Trainer: _____

Date of Training: _____

The employee named above was instructed in the operation of the
laser system. Especially the following topics were covered:

- Machine function
- Danger areas
- Warnings
- Position of the Emergency stop button
- Personal protective equipment
- Operating equipment
- Workflow
- Setting-up
- Startup and Shutdown
- Reporting of unexpected working results and actions to be taken.
- Reporting of failure and actions to be initiated.
- Responsibility for troubleshooting.
- Operating manual and it's storage location for inspection.

Signature Trainer

Signature Trainee

Response form

Dear customer!

In case of any trouble with the machine, please provide the following information and additionally create a service file.

Contact details

Name: _____
Country: _____
Phone: _____
E-mail: _____
Date: _____

Machine data

Serial number: _____
Layout Software: _____

Description of the problem

Does an error message show up on the PC , and if so, which?

What happened before the error occurred? (Thunder and lightning, Windows-Update...)

What attempts were made to solve the problem?

Please send the information to your sales representative, to your local support or to following e-mail address: techsupport@troteclaser.com.

Speedy 360

Laser engraving system

Mechanics

Working area	813 x 508 mm (32 x 20 inch)
Loading area standard	890 x 600 mm (35 x 23.6 inch)
Max. height of work piece	210 mm (8.2 inch) with 1.5 inch, 2.0 inch lens 197,5 mm (7.7 inch) with 2.0 inch clearance lens, 2.5 inch lens 159 mm (6.2 inch) with 4.0 inch 146,5 mm (5.7 inch) with 4.0 inch clearance lens
Working table	Multifunctional table concept, Rulers in mm or inches Electronic, programmable Z-axis with servo motor
Max. processing speed	355 cm/s (140 ips)
Acceleration	50 m/s ² (1969 ips ²)
Motors	Brushless DC servo motors
Encoder	Incremental measuring system
Optical elements	Telescope, mirrors, lens
Lens	1.5 inch, 2.0 inch, 2.0 inch clearance, 2.5 inch, 4.0 inch, 4.0 inch clearance
Accuracy	+/- 0.015 mm (0.0006 inch), over the whole working area
Addressable accuracy	5 µm (0.0002 inch)
Accuracy to size of parts	According to material and process
Maximum material load	Static: up to 100kg (220 lbs), Dynamic: up to 30 kg (66 lbs) load over the whole working area
Interface	Ethernet, optional Wifi

Features standard

Lens	2.0 inch
InPack Technology™	Protects working head and all moving parts from dust
Exhaust	Surface exhaust via rear of the engraving cabinet, table exhaust with vacuum and cutting tables
Software	Ruby®
Operating console	Touch panel, keypad, safety-switch, system turnkey
Table	Aluminum cutting grid table
Laser Pointer	655 nm, <0,99 mWcw
Autofocus	Sonar Technology™ and software
Work area light	LED
Additional standard features	Ergonomic access to working area, OptiMotion™, coaxial air assist incl. integrated pump, harsh environment protection kit, integrated extraction slits, two Z-Home positions, air-assist nozzles (Ø3mm and Ø7 mm), lockable casters

Options

Vision Design&Position	Design and Position job in live view of work area on Ruby screen.
Temperature sensor	Should the temperature inside the engraving compartment exceed a critical value, the system will signal this to the operator by a warning sound. The operator then can take action immediately.
Gas-Kit light	Control of external supplied compressed air (free of mechanical dust, water and oil) max. flow rate 150 l/min (40 gpm) with max. 10 bar (145 psi);
Water cooling preparation	Additional parts to connect an external cooler
Screw feet	Additional to the rolls, for a good standing on the ground
Industrial interface	Start / Stop /... signals to control the operation from extern

Accessories

Vision Print&Cut	Registration marks detection and compensation system Max. working area without camera: 813 x 508 mm (32 x 20 inch) Max working area with camera: 801 x 508 mm (31.5 x 20 inch)
Ferromagnetic engraving table	Allows to mount thin materials such as paper, films or foils with magnets to ensure an even and flat surface to achieve optimal results
Vacuum table	Vacuum effect for fixation of thin or wavy materials
Acrylic cutting grid table (white)	Reflection free cutting of parts smaller than 100 mm (4 inch)
Slat cutting table	Cutting of thicker materials and parts bigger than 100 mm (4 inch); removable aluminium and acrylic slats, x-axis ruler can be removed and mounted again without re-adjustment
Honeycomb cutting table	Good compromise between the Grid and Slat table configuration. Thin support structures reduce flashback compared to a grid table. High density of the honeycomb structure provides good support for less rigid material such as thin plastic, card & paper or membrane boards; nominal comb size 12,7 mm (0.5 inch) or 6,4 mm (0.25 inch)
Rotary attachment	Cone, roll or combined version, tilt able Max. workpiece length cones: 550 mm (21.6 inch) Max. workpiece length rolls: $\varnothing \geq 58$ mm (2.2 inch) = 679 mm (26.7 inch), $\varnothing \leq 58$ mm (2.2 inch) = 745 mm (29.3 inch) Max. workpiece diameter cones: 207 mm (8.1 inch), depending on lens Max. workpiece diameter rolls: 96 mm (3.7 inch), depending on lens
TroCare	Comprehensive package of technical services

Laser

Laser system CO ₂	Sealed-off laser, maintenance free, air cooled, wavelength 10.6 μ m 60, 80, 100 and 120 W
------------------------------	--

Dimensions & weight

Width x Depth x Height	1221 x 830 (790*) x 1066 mm (48 x 32.8 (30.7*) x 42.0 inch) * top lid closed, without mounted exhaust hose connections, gas-kit light
Weight	Approx. 235 – 250 kg / 518 - 551 lbs (depending on laser power)

Safety & environment

Laser class	CDRH laser class 2
Interlock	Dual-channel interlock safety system
Ambient conditions	Mandatory ambient temperature +15° to +25° C or 59° to 77° F Humidity 40% to max. 70%, not condensing Dust free environment (2nd degree according to IEC 60947-1)
Certificates	CE compliant, FDA listed

Exhaust

Minimum volume required (without piping/tubing)	350 m ³ /h at 3.500 Pa Two connections
Required	Atmos Duo Plus (or equivalent systems, all table concepts) Vent Set 400 (or equivalent systems; all table concepts except vacuum table/strong vacuum effect) Vent Set 500 (or equivalent systems, all table concepts incl. vacuum table/strong vacuum effect)

Cooling

Air cooling	Active air flow cooling with fan
Liquid cooling	Optional available for CO ₂ laser sources 60 – 120 watts with external liquid cooler

Electrical

Voltage & power consumption	1 ~ AC 110-230V 50/60Hz, approx. 1200 W to 1900 W (depending on laser power)
-----------------------------	--

Subject to change without notice. Errors and omissions reserved.

Model identification Speedy 360C-8069

January 2022 – updated March 2022

EC-Declaration of Conformity

According to Machine Directive 2006/42/EC, Annex II 1. A

trotec

Manufacturer:

Trotec Laser GmbH
Freilinger Straße 99
4614 Marchtrenk
Austria

Authorized person to compile the technical files:

Trotec Laser GmbH
Freilinger Straße 99
4614 Marchtrenk
Austria

Description and Identification of the machine:

Product description	Laser cutting and engraving system
Model name	Speedy 360 , Speedy 360 flexx
Model identification	Speedy 360C-8069, Speedy 360X-8069
Serial number	S36-4### , X36-4###
Machine group	8069
Function	System for laser cutting and laser engraving

It is declared expressly that the machine fulfills all of the following applicable EC directives and regulations:

2006/42/EC	EC Machine Directive 2006/42/EC
2014/30/EU	Directive 2014/30/EU Electromagnetic Compatibility

Reference to the harmonized standards in accordance with article 7 (2):

ISO 11553-1:2008	Safety of machinery – Laser processing machines Part 1: General safety requirements
ISO 12100:2010	Safety of machinery – General principles for design - Risk assessment and risk reduction
ISO 13849-1:2018	Safety of machinery – Safety related parts of control systems Part 1: General principles for design
IEC 60204-1:2018	Safety of machinery – Electrical equipment of machines Part 1: General requirements
IEC 60825-1:2015	Safety of laser products - Part 1: Equipment classification and requirements
IEC 61000-3-2:2019	Electromagnetic compatibility - Part 3-2: Limits for harmonic current emissions
IEC 61000-3-3: 2013 +A1:2019	Electromagnetic compatibility - Part 3-3: Limitation of voltage changes / fluctuations and flicker
IEC 61000-6-2:2019	Electromagnetic compatibility - Part 6-2: Immunity standard for industrial environments
IEC 61000-6-4:2019	Electromagnetic compatibility - Part 6-4: Emission standard for industrial environments

Further Reference to the harmonized standards in accordance with article 7 (2):

IEC 60825-4:2012	Safety of laser products - Part 4: Laser guards
------------------	---

Marchtrenk, 25. April 2022

City, Date

trotec

Trotec Laser GmbH
Freilinger Strasse 99, A-4614 Marchtrenk
T +43 7242 239-0
www.troteclaser.com

pp. Hagen Strasser
Head of Research and Development